

Panasonic
ideas for life

**MINIATURE RELAY FOR
WIDER APPLICATIONS**

HC RELAYS

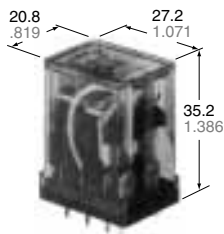
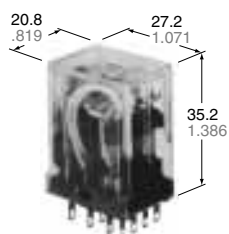

mm inch

HCE Amber Relays

FEATURES

- **Extra long life — Min. 10⁸ mechanical operations (DC type)**
- **4 contact arrangements**
4 Form C (for 5 A 250 V AC),
3 Form C (for 7 A 250 V AC),
2 Form C (for 7 A 250 V AC),
1 Form C (for 10 A 250 V AC)
- **Applicable to low to high level loads (100µA to 10A)**
- **Amber sealed types available**
- **Bifurcated contact types available as HC4D**

SPECIFICATIONS

Contacts

| Arrangement | | 1 Form C | 2 Form C | 3 Form C | 4 Form C |
|---|---------------------------------------|---------------------------|-----------------|-----------------|-------------------------|
| Initial current resistance, max. (By voltage drop 6 V DC 1 A) | | 30 mΩ | | | |
| Contact material | | Gold-flashed silver alloy | | | Gold-clad silver nickel |
| Rating (resistive) | Nominal switching capacity | 10 A 250 V AC | 7 A 250 V AC | 7 A 250 V AC | 5 A 250 V AC |
| | Max. switching power | 2,500 VA | 1,750 VA | 1,750 VA | 1,250 VA |
| | Max. switching voltage | 250 V AC | | | |
| | Max. switching current | 10 A | 7 A | 7 A | 5 A |
| | Min. switching capacity ^{#1} | 1 mA, 1 V DC | | | |

Coil

| | |
|-------------------------|--|
| Nominal operating power | AC (50Hz): 1.3VA, AC (60Hz): 1.2 VA DC: 0.9 to 1.1W |
|-------------------------|--|

#1 This value can change due to the switching frequency, environmental conditions, and desired reliability level, therefore it is recommended to check this with the actual load.

Remarks

* Specifications will vary with foreign standards certification ratings.

*1 Detection current: 10 mA

*2 Excluding contact bounce time

*3 Half-wave pulse of sine wave: 11ms; detection time: 10µs

*4 Half-wave pulse of sine wave: 6ms

Characteristics

| | | |
|--|--------------------------|---|
| Max. operating speed | | 20 cpm (at max. rating) |
| Initial insulation resistance | | Min. 1,000 MW at 500 V DC |
| Initial breakdown voltage*1 | Between open contacts | 700 Vrms for 1 min. |
| | Between contact sets | 700 Vrms for 1 min. |
| | Between contact and coil | 2,000 Vrms for 1 min. |
| Operate time*2 (at nominal voltage) (at 20°C) | | Max. 20 ms (DC, AC type) |
| Release time (without diode)*2 (at nominal voltage) (at 20°C) | | Max. 20 ms (DC, AC type) |
| Temperature rise, max. (at 70°C) (at nominal voltage) | | 80°C |
| Shock resistance | Functional*3 | Min. 196 m/s ² {20 G} |
| | Destructive*4 | Min. 980 m/s ² {100 G} |
| Vibration resistance | Functional*5 | 10 to 55 Hz at double amplitude of 1 mm |
| | Destructive | 10 to 55 Hz at double amplitude of 2 mm |
| Conditions for operation, transport and storage*6 (Not freezing and condensing at low temperature) | Ambient temp. | -50°C to +70°C -58°F to +158°F |
| | Humidity | 5 to 85% R.H. |
| Unit weight | | Approx. 30g 1.06 oz |

*5 Detection time: 10µs

*6 Refer to 6. Conditions for operation, transport and storage mentioned in AMBIENT ENVIRONMENT

Expected life (min. operations)

Electrical (at 20 cpm)

| Voltage | | 125 V AC | | 250 V AC | | 30 V DC | | Expected life |
|----------------|---------|-----------------------|-------------------------|-----------------------|-------------------------|-----------|-----------|-------------------|
| Load | | Resistive (cos φ = 1) | Inductive (cos φ ≐ 0.4) | Resistive (cos φ = 1) | Inductive (cos φ ≐ 0.4) | Resistive | Inductive | |
| HC1 (1 Form C) | Current | 10A | 5A | 10A | 3A | — | — | 2×10 ⁵ |
| | | 7A | 3A | 7A | 2.5A | 3A | 1A | 5×10 ⁵ |
| | | 5A | 2A | 5A | 1.5A | — | — | 1×10 ⁶ |
| HC2 (2 Form C) | Current | 7A | 3.5A | 7A | 2A | — | — | 2×10 ⁵ |
| | | 5A | 2.5A | 5A | 1.5A | 3A | 0.6A | 5×10 ⁵ |
| | | 3A | 1.5A | 3A | 1A | — | — | 1×10 ⁶ |
| HC3 (3 Form C) | Current | 7A | — | 7A | — | — | — | 1×10 ⁵ |
| | | — | 3.5A | — | 2A | — | — | 2×10 ⁵ |
| | | 5A | — | 5A | — | 3A | 0.4A | 5×10 ⁵ |
| HC4 (4 Form C) | Current | 5A | 2A | 5A | 1A | — | — | 2×10 ⁵ |
| | | 3A | 1A | 3A | 0.8A | 3A | 0.4A | 5×10 ⁵ |
| | | 2A | 0.5A | 2A | 0.4A | — | — | 1×10 ⁶ |

Mechanical life (at 180 cpm)

DC type: 10⁸, AC type: 5×10⁷

TYPICAL APPLICATIONS

Transportation, power station control equipment, refrigerators, building control equipment, office machines, coin

operated machines, amusement devices, medical equipment, etc.

ORDERING INFORMATION

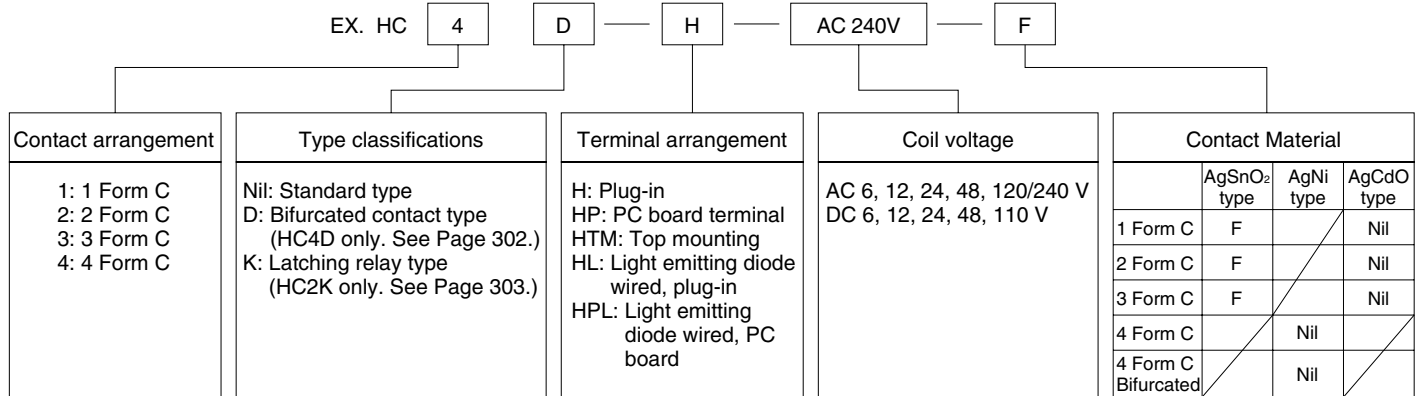

Notes:

- When ordering VDE recognized types, add suffix VDE.
- HC3 (3 Form C) series are not approved by VDE.
- AC 48 V type is not available for LED wiring.
- Standard packing Carton: 20 pcs.; Case: 200 pcs.
- UL/CSA approved type is standard.

COIL DATA (Common for Standard, Amber sealed and Bifurcated contact types)

DC Type at 20°C 68°F

| Coil voltage, V DC | Pick-up voltage, V DC (max.) | Drop-out voltage, V DC (min.) | Max. allowable voltage, V DC | Coil resistance, Ω (±10%) | Nominal coil current, mA (±10%) | Operating power, W | |
|--------------------|------------------------------|-------------------------------|------------------------------|---------------------------|---------------------------------|--------------------|---------|
| | | | | | | Nominal | Minimum |
| 6 | 4.8 | 0.6 | 6.6 | 40 | 150 | 0.9 | 0.58 |
| 12 | 9.6 | 1.2 | 13.2 | 160 | 75 | 0.9 | 0.58 |
| 24 | 19.2 | 2.4 | 26.4 | 650 | 37 | 0.9 | 0.58 |
| 48 | 38.4 | 4.8 | 52.8 | 2,600 | 18.5 | 0.9 | 0.58 |
| 110 | 88.0 | 11.0 | 121.0 | 10,000 | 10 | 1.0 | 0.64 |

AC Types (50/60 Hz) at 60 Hz, 20°C 68°F

| Coil voltage, V AC | Pick-up voltage, V AC (max.) | Drop-out voltage, V AC (min.) | Max. allowable voltage, V AC | Nominal coil current, mA (±20%) | Operating power, VA | |
|--------------------|------------------------------|-------------------------------|------------------------------|---------------------------------|---------------------|---------|
| | | | | | Nominal | Minimum |
| 6 | 4.8 | 1.8 | 6.6 | 200 | 1.20 | 0.77 |
| 12 | 9.6 | 3.6 | 13.2 | 100 | | |
| 24 | 19.2 | 7.2 | 26.4 | 50 | | |
| 48 | 38.4 | 14.4 | 52.8 | 25 | | |
| 110/120 | 96 | 36 | 132 | 10.9/11.9 | | |
| 220/240 | 176.0 | 66.0 | 264.0 | 6.0/6.5 | | |

NOTES:

1. The range of coil current is ±15% for AC (60 Hz), and ±10% for DC, at 20°C.
2. The relay is applicable to the range of 80% to 110% of the nominal coil voltage. However, it is recommended that the relay be used in the range of 85% to 110% to take temporary voltage variations into consideration.

3. The coil resistance of DC types is the measured value at a coil temperature of 20°C. Please compensate coil resistance by ±0.4% for each degree centigrade coil temperature change.

4. All AC 240 V types are rated for double coil voltages, both AC 220 V and AC 240 V.

5. For use with 220 V or 240 V DC, connect a resistor as suggested in the chart below, in series with the 110 V DC relay.

| Voltage | 1 Form C, 2 Form C, 3 Form C, 4 Form C |
|----------|--|
| 220 V DC | 11 kΩ (5 W) |
| 240 V DC | 13 kΩ (5 W) |

DIMENSIONS (Common for standard, Amber sealed and Bifurcated contact (4C only) types)

Plug-in type

HC1-H (1 Form C)

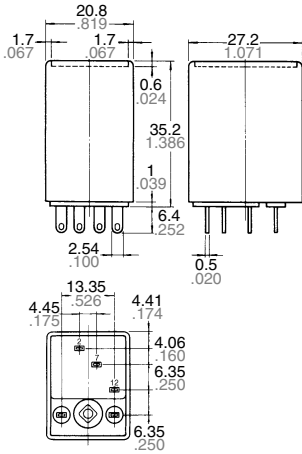

HC2-H (2 Form C)

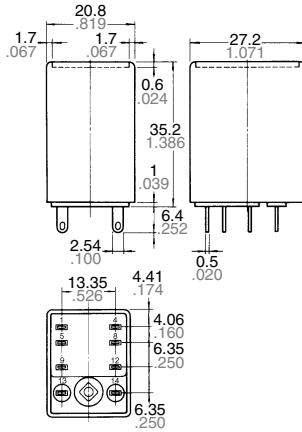

HC3-H (3 Form C)

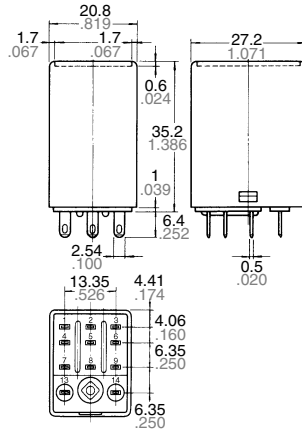

HC4-H (4 Form C)

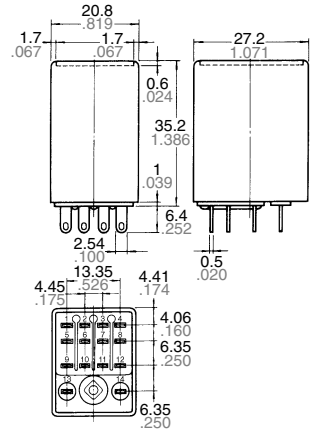

General tolerance: $\pm 0.2 \pm .008$

PC board type

HC4-H (4 Form C)

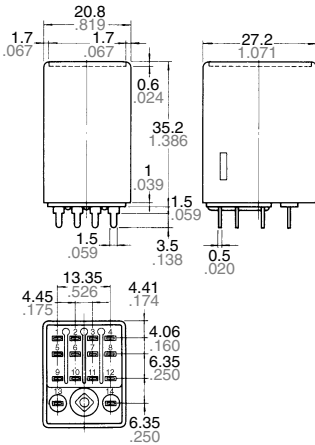

Dimensions of HC1-HP, HC2-HP, HC3-HP are the same as those of plug-in type except shapes of terminals.

General tolerance: $\pm 0.2 \pm .008$

PC board pattern (Copper-side view)

1c

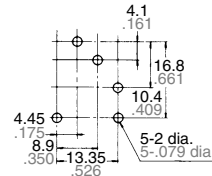

2c

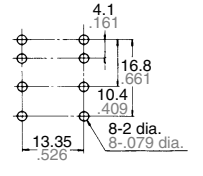

3c

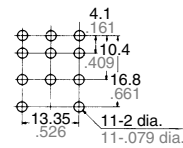

4c

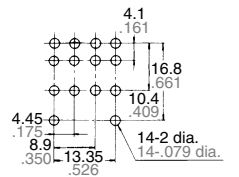

Tolerance: $\pm 0.1 \pm .004$

Note: Special PC terminal with 0.9 mm (.035 inch) width available with suffix "-31".

Schematic (bottom view)

HC1-H, HC1-HP (1 Form C)

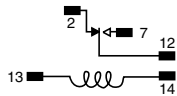

LED AC type

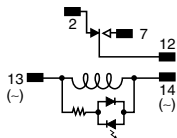

LED DC type

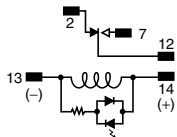

HC2-H, HC2-HP (2 Form C)

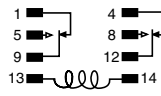

LED AC type

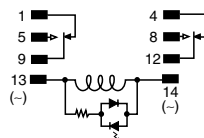

LED DC type

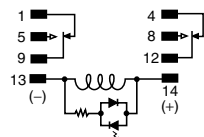

HC3-H, HC3-HP (3 Form C)

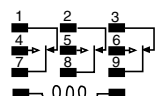

LED AC type

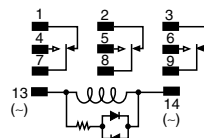

LED DC type

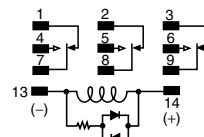

HC4-H, HC4-HP (4 Form C)

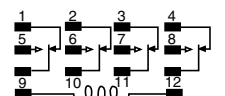

LED AC type

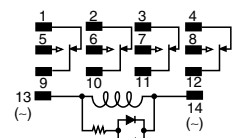

LED DC type

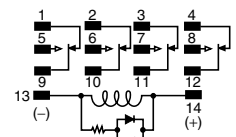

REFERENCE DATA

1. Life curve

Load: 250 V AC resistive load

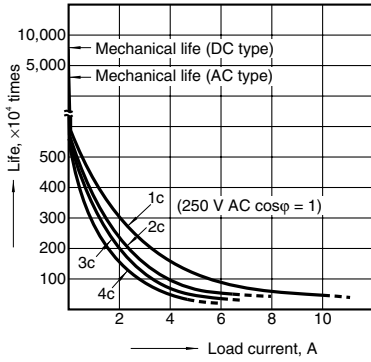

2. Switching capacity range

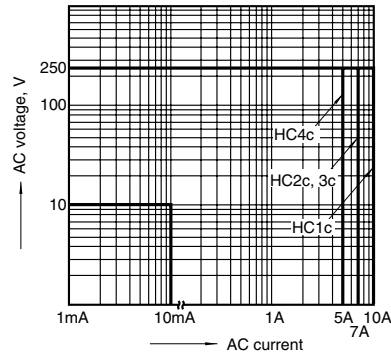

3. H2S gas test

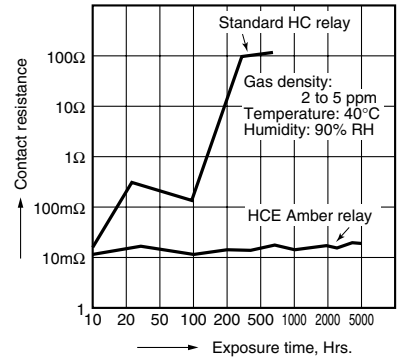

4. Coil temperature rise

Measured portion: Inside the coil Note: When the nominal voltage is applied to AC 120 or 240 V coil types respectively, the figures of coil temperature rise increase by approx. 10 degrees to the ones shown on each graph.

HC1 AC coil

Ambient temperature: 25°C 77°F

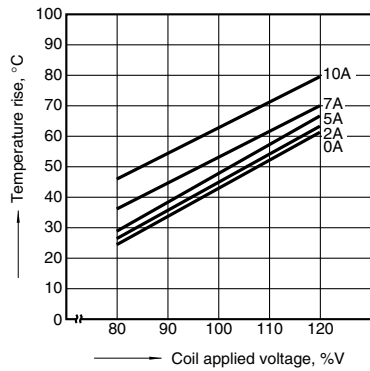

HC2 AC coil

Ambient temperature: 30°C 86°F

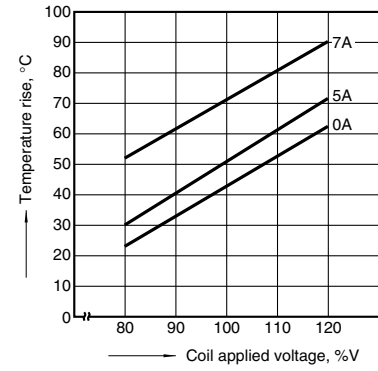

HC3 AC coil

Ambient temperature: 18°C 64°F

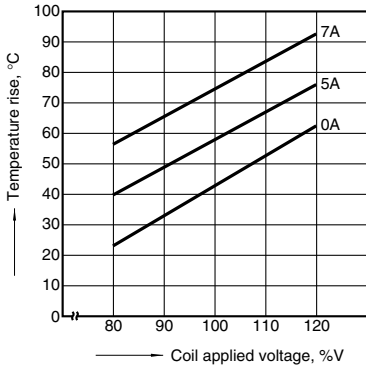

HC4 AC coil

Ambient temperature: 15 to 21°C 59 to 70°F

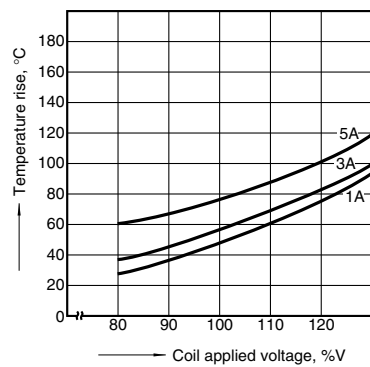

HC1 DC coil

Ambient temperature: 29°C 84°F

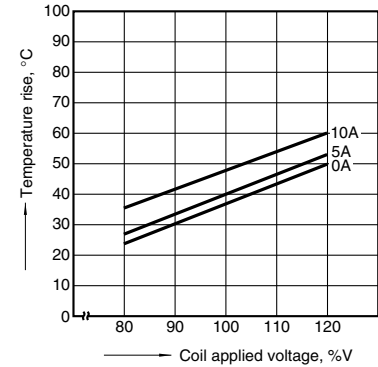

HC2 DC coil

Ambient temperature: 29°C 84°F

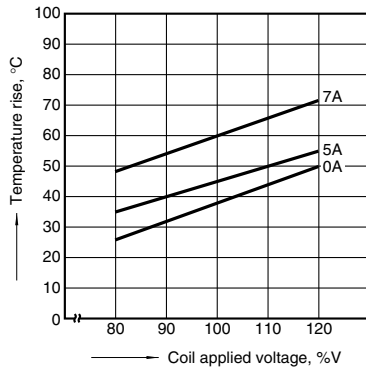

HC3 DC coil

Ambient temperature: 29°C 84°F

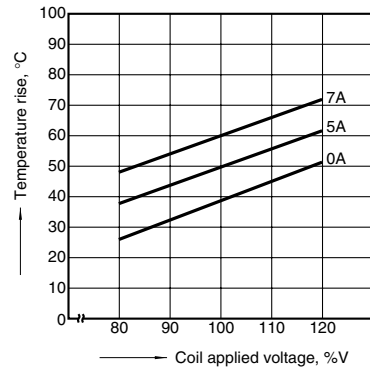

HC4 DC coil

Ambient temperature: 17 to 18°C 62 to 64°F

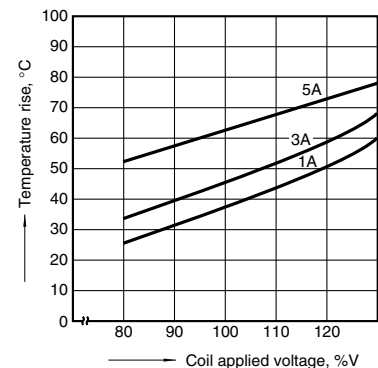

Amber Relays HCE

HC sealed relays are version of the HC relays and are recommended for use in switching medium loads under adverse ambient conditions. They show highly stable contact resistance even after long use, due to their sealed construction and reliable gold plated contacts. Amber relays also make the combined process of automatic wave soldering and cleaning process possible with their resultant savings in cost and labor. Contact

arrangements of 1 Form C, 2C, and 4C are available for plug-in, PC board and top-mount.

Construction

The diagram at right shows a cross-section of the plastic sealed relay. All the plastic parts are annealed and out-gassed to ensure fully the stability of both chemical and physical characteristics.

Sealed construction

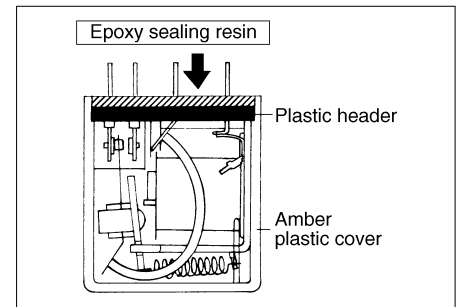

SPECIFICATIONS

Contacts

| Contact arrangement | | 1 Form C | 2 Form C | 4 Form C |
|--|---------------------------------------|--------------------------------|--------------|--------------|
| Rating (resistive) | Nominal switching capacity | 5 A 250 V AC | 3 A 250 V AC | 2 A 250 V AC |
| | Max. switching power | 1,250 VA | 700 VA | 500 VA |
| | Max. switching voltage | 250 V AC | | |
| | Max. switching current | 5 A | 3 A | 2 A |
| | Min. switching capacity ^{#1} | 1 mA, 100 mV DC | | |
| Conditions for operation, transport and storage (Not freezing and condensing at low temperature) | Ambient temp. | -40°C to +60°C -40°F to +140°F | | |
| | Humidity | 5 to 85% R.H. | | |
| Ambient air pressure | | 760 mmHg +20% (1.013 mb +20%) | | |

Expected life (min. operations)

| Electrical (at 20 cpm) | Voltage | | 125 V AC | 250 V AC | 30 V DC | | Expected life |
|------------------------------|-----------------|---------|---|-----------------------|-----------|-----------|-------------------|
| | Load | | Resistive (cos φ = 1) | Resistive (cos φ = 1) | Resistive | Inductive | |
| Mechanical life (at 180 cpm) | HC1E (1 Form C) | Current | 5 A | 5 A | 3 A | 1 A | 2×10 ⁵ |
| | HC2E (2 Form C) | Current | 3 A | 3 A | 2 A | 1.7 A | |
| | HC4E (4 Form C) | Current | 2 A | 2 A | 2 A | 0.6 A | |
| | | | DC type: 10 ⁸ , AC type: 5×10 ⁷ | | | | |

Characteristics

| | |
|--------------|------------|
| Operate time | Max. 20 ms |
| Release time | Max. 20 ms |

^{#1} This value can change due to the switching frequency, environmental conditions, and desired reliability level, therefore it is recommended to check this with the actual load.

ORDERING INFORMATION

| Contact arrangement | Type classifications | Terminal arrangement | Coil voltage | Contact Material | | | | | | | | | | | | | | | | | | | | |
|---|---|--|---|--|--|-------------------------|-----------|------------|----------|---|--|-----|----------|---|--|-----|----------|--|-----|--|---------------------|--|-----|--|
| 1: 1 Form C 2: 2 Form C 4: 4 Form C | Nil: Standard type D: Bifurcated contact type (HC4D only. See Page 302.) | H: Plug-in HP: PC board terminal HTM: Top mounting L: Light emitting diode wired, plug-in PL: Light emitting diode wired, PC board | AC 6, 12, 24, 48, 120, 240 V DC 6, 12, 24, 48, 110 V | <table border="1"> <thead> <tr> <th></th> <th>AgSnO₂ type</th> <th>AgNi type</th> <th>AgCdO type</th> </tr> </thead> <tbody> <tr> <td>1 Form C</td> <td>F</td> <td></td> <td>Nil</td> </tr> <tr> <td>2 Form C</td> <td>F</td> <td></td> <td>Nil</td> </tr> <tr> <td>4 Form C</td> <td></td> <td>Nil</td> <td></td> </tr> <tr> <td>4 Form C Bifurcated</td> <td></td> <td>Nil</td> <td></td> </tr> </tbody> </table> | | AgSnO ₂ type | AgNi type | AgCdO type | 1 Form C | F | | Nil | 2 Form C | F | | Nil | 4 Form C | | Nil | | 4 Form C Bifurcated | | Nil | |
| | AgSnO ₂ type | AgNi type | AgCdO type | | | | | | | | | | | | | | | | | | | | | |
| 1 Form C | F | | Nil | | | | | | | | | | | | | | | | | | | | | |
| 2 Form C | F | | Nil | | | | | | | | | | | | | | | | | | | | | |
| 4 Form C | | Nil | | | | | | | | | | | | | | | | | | | | | | |
| 4 Form C Bifurcated | | Nil | | | | | | | | | | | | | | | | | | | | | | |

UL/CSA approved type is standard.

REFERENCE DATA (HC Amber Relays)

1. Switching capacity range

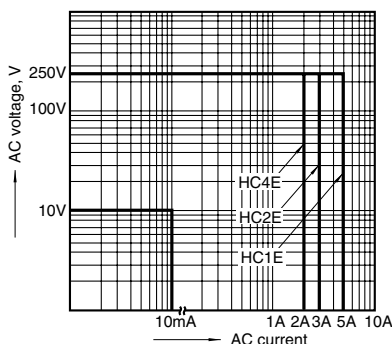

2.-(1) Coil temperature rise (1c AC type)

Measured portion: Inside the coil
Ambient temperature 30°C 86°F

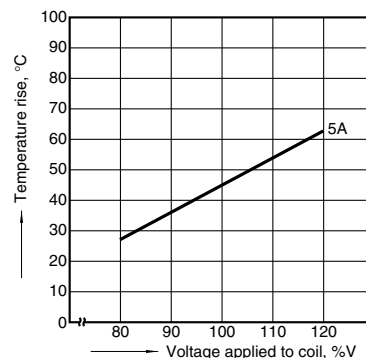

2.-(2) Coil temperature rise (2c AC type)

Measured portion: Inside the coil
Ambient temperature: 30°C 86°F

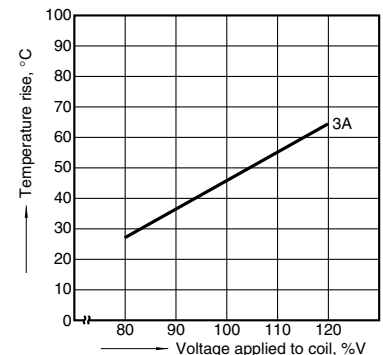

HC

2.-(3) Coil temperature rise (4c AC type)

Measured portion: Inside the coil
Ambient temperature: 30°C 86°F

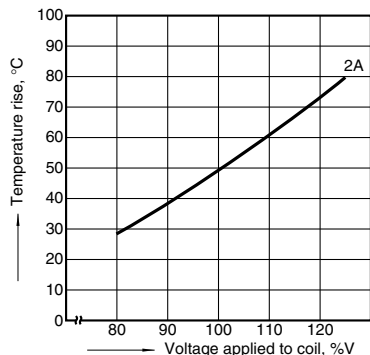

2.-(4) Coil temperature rise (1c DC type)

Measured portion: Inside the coil
Ambient temperature: 30°C 86°F

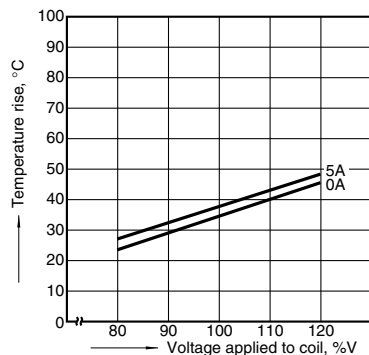

2.-(5) Coil temperature rise (2c DC type)

Measured portion: Inside the coil
Ambient temperature: 30°C 86°F

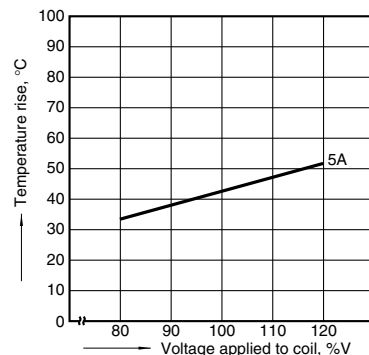

Bifurcated contact types HC4D

Extremely high contact reliability has been made possible by adoption of gold-clad bifurcated contacts for both movable and stationary contacts.

HC4D type can be used from the dry circuit 100 μ A at 10 V DC to the power circuit 3 A at 250 V AC resistive load.

Therefore, with HC4D type such a usage is possible that one contact switches 100 μ A and another contact switches 3 A load. Also Amber sealed types are available as HC4ED relays.

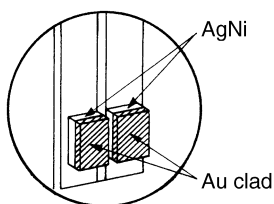

SPECIFICATIONS

Contacts

| | | | |
|---------------------|----------------------------|--|--|
| Contact arrangement | 4 Form C only | | |
| Contact material | Gold-clad silver nickel | | |
| Rating (resistive) | Nominal switching capacity | 3 A 250 V AC | |
| | Max. switching power | 750 VA | |
| | Max. switching current | 3A | |
| | Min. switching capacity#1 | (HC4D) 100 μ A, 1 V DC (HC4ED) 100 μ A, 100 mV DC | |

Characteristics

| | |
|------------------------|------------|
| Operate time (Approx.) | Max. 20 ms |
| Release time (Approx.) | Max. 20 ms |

#1 This value can change due to the switching frequency, environmental conditions, and desired reliability level, therefore it is recommended to check this with the actual load.

Expected life (min. operations)

Electrical (at 20 cpm)

| Voltage | 125 V AC | | 250 V AC | | 30 V DC | Expected life |
|---------|-----------------------------|-----------------------------------|-----------------------------|-----------------------------------|---------|----------------------------|
| | Resistive (cos $\phi = 1$) | Inductive (cos $\phi \cong 0.4$) | Resistive (cos $\phi = 1$) | Inductive (cos $\phi \cong 0.4$) | | |
| HC4D | 3 A | 1 A | 3 A | 0.8 A | 3 A | 2 \times 10 ⁵ |
| HC4ED | 1 A | — | 1 A | — | — | |

REFERENCE DATA

1. Switching capacity range

Standard type

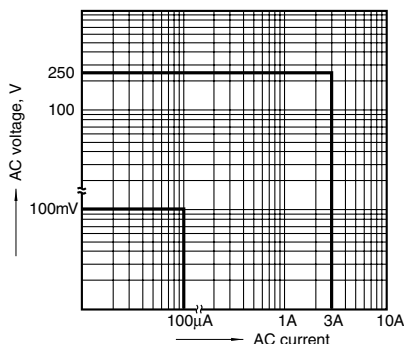

Amber type

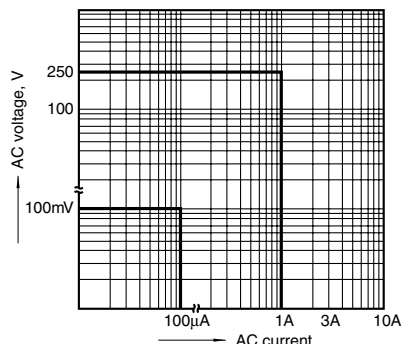

Latching relay types: HC2K

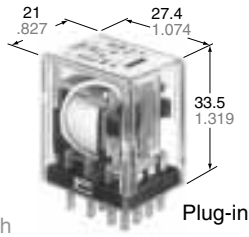

HC magnetic latching relays are particularly suitable for various vending machines, remote control devices, parking meters, conveyor, NC machinery, etc.

TYPES AND COIL DATA

DC coils at 20°C 68°F

UL, CSA recognized

| Part No. | | Nominal coil current (mA) | | Nominal operating power (VA) | | Coil voltage | |
|------------------|--------------------|---------------------------|-------|------------------------------|-------|------------------------|-------------------------|
| Plug-in | PC board terminal | set | reset | set | reset | Pick-up | Max. allowable |
| HC2K-DC6V (-F) | HC2K-P-DC6V (-F) | 207 | 107 | 1.24 | 0.64 | 80% of Nominal voltage | 110% of Nominal voltage |
| HC2K-DC12V (-F) | HC2K-P-DC12V (-F) | 100 | 52.2 | 1.20 | 0.63 | | |
| HC2K-DC24V (-F) | HC2K-P-DC24V (-F) | 51.1 | 25.5 | 1.23 | 0.61 | | |
| HC2K-DC48V (-F) | HC2K-P-DC48V (-F) | 25.3 | 13.7 | 1.21 | 0.66 | | |
| HC2K-DC100V (-F) | HC2K-P-DC100V (-F) | 15.6 | 5.8 | 1.56 | 0.58 | | |



Plug-in

AC coils

| Part No. | | Nominal coil current (mA) | | Nominal operating power (VA) | | Coil voltage | |
|------------------|--------------------|---------------------------|-------|------------------------------|-------|------------------------|-------------------------|
| Plug-in | PC board terminal | set | reset | set | reset | Pick-up | Max. allowable |
| HC2K-AC6V (-F) | HC2K-P-AC6V (-F) | 206 | 103 | 1.23 | 0.62 | 80% of Nominal voltage | 110% of Nominal voltage |
| HC2K-AC12V (-F) | HC2K-P-AC12V (-F) | 100 | 52 | 1.20 | 0.62 | | |
| HC2K-AC24V (-F) | HC2K-P-AC24V (-F) | 51 | 21.4 | 1.22 | 0.51 | | |
| HC2K-AC48V (-F) | HC2K-P-AC48V (-F) | 25.2 | 18.5 | 1.2 | 0.88 | | |
| HC2K-AC115V (-F) | HC2K-P-AC115V (-F) | 10.4 | 5.4 | 1.20 | 0.621 | | |



PC board terminal

HC2K AC types are not recognized by UL, CSA.

Notes: 1. The coil current range is $\pm 10\%$ of the nominal coil current.

2. The relay is suitable to the range of 80% — 110% of the nominal coil voltage. However, it is recommended that the relay be used in the range of 85% — 110% of the nominal coil voltage, with the temporary voltage variation taken into consideration.

3. UL/CSA approved type is standard.

SPECIFICATIONS

Contacts

| | | |
|--|---------------------------------------|--------------|
| Arrangement | 2 Form C only | |
| Initial contact resistance max. (By voltage drop 6 V DC 1 A) | 50 m Ω | |
| Rating (resistive) | Nominal switching capacity | 3 A 250 V AC |
| | Max. switching power | 750 VA |
| | Max. switching current | 3A |
| | Min. switching capacity ^{#1} | 1 mA, 1 V DC |

Coil

| | | |
|-------------------------|------------|--------------------|
| Nominal operating power | Set coil | 1.2 VA to 1.33 VA |
| | Reset coil | 0.51 VA to 0.88 VA |

#1 This value can change due to the switching frequency, environmental conditions, and desired reliability level, therefore it is recommended to check this with the actual load.

Characteristics

| | | |
|---|------------------------------------|---|
| Initial breakdown voltage | Between contact and coil | 1,500 Vrms for 1 min. |
| Set time (at nominal voltage) (at 20°C) | | AC, DC: Approx. 20 ms |
| Reset time (at nominal voltage) | | AC: Approx. 30 ms DC: Approx. 50 ms |
| Temperature rise (at nominal voltage) | Set coil | Max. 80°C |
| | Reset coil | Max. 50°C |
| Shock/vibration resistance | | Min. 98 m/s ² (10 G) |
| Expected life (min. operations) | Mechanical (at 180 cpm) | 10 ⁷ |
| | Electrical (resistive) (at 20 cpm) | 2 \times 10 ⁵ |
| Ambient temperature | | -40°C to +50°C -40°F to +122°F (Not freezing and condensing at low temperature) |

DIMENSIONS AND CIRCUIT DIAGRAM

mm inch

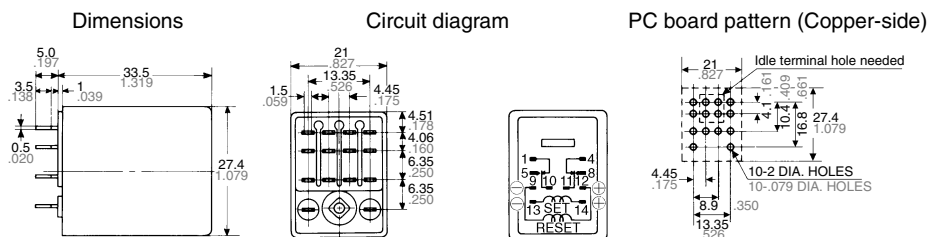

General tolerance: $\pm 0.5 \pm 0.20$

Tolerance: $\pm 0.1 \pm 0.004$

Notes:

1. Configuration and dimensions of HC2K types are the same as those of standard HC4 types. Standard sockets and screw terminal sockets of HC4 can be used: HC4-SS-K, HC4-PS-K, HC4-WS-K, and HC4-HSF-K.

2. Please note that circuit diagram of HC2K is different from HC4.

3. Avoid operation by capacitor since latching force varies according to input pulse voltage.







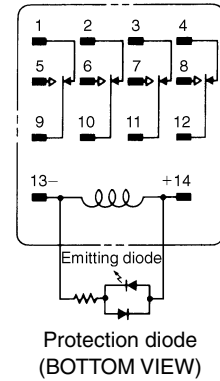
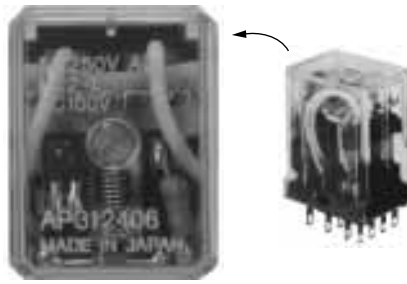







HC

LED wired types: HC-L

The built-in indication LED (Light emitting diode) Series are suitable for instant indication of operate function in applications where numerous relays are to be used. The HC-L relays are supplied with LED wired in parallel with the coil for visual indication that the relay is functioning. A Red LED is used for AC type and green one for DC.



ACCESSORIES

| Relay Socket | HC1 (1 Form C) | HC2 (2 Form C) | HC3 (3 Form C) | HC4 (4 Form C) |
|---|---|--|---|---|
| Socket with solder tab (with hold-down clip) |  HC1-SS-K |  HC2-SS-K |  HC3-SS-K |  HC4-SS-K |
| PC board socket (with hold-down clip) |  HC1-PS-K |  HC2-PS-K |  HC3-PS-K |  HC4-PS-K |
| Socket for wrap wiring (with hold-down clip) | — | — | — |  HC4-WS-K |
| Screw terminal socket for front wiring (with hold-down clip) | — |  HC2-SF-K Exclusively for HC2-H |  HC3-HSF-K For HC2-H, HC3-H |  HC4-HSF-K For HC1-H, HC2-H, HC4-H |
| Screw terminal socket for DIN rail assembly (with hold-down clip) | — |  HC2-SFD-S HC2-SFD-K Exclusively for HC2-H |  HC3-SFD-K For HC2-H, HC3-H |  HC4-SFD-K For HC1-H, HC2-H, HC4-H |

DIMENSIONS

Socket with solder tab (with hold-down clip)

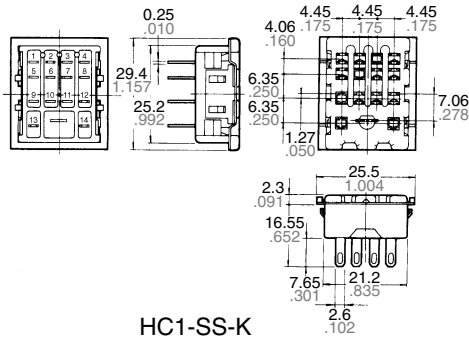

HC1-SS-K

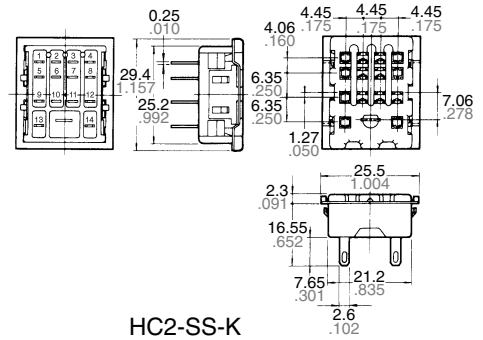

HC2-SS-K

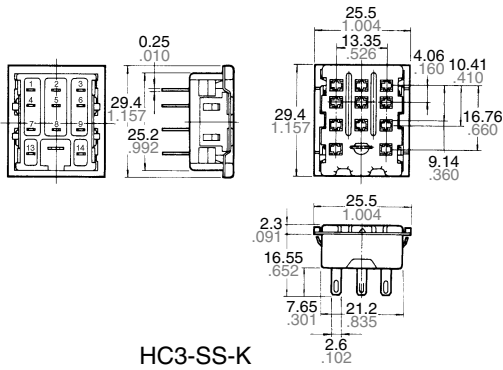

HC3-SS-K

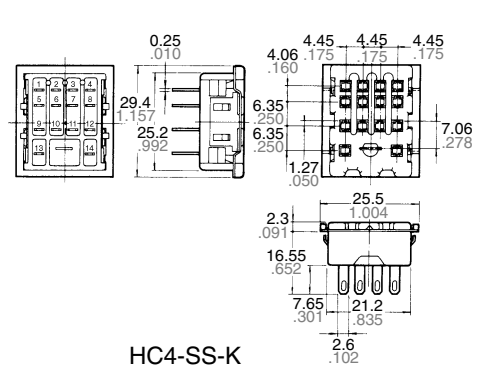

HC4-SS-K

PC board socket (with hold-down clip)

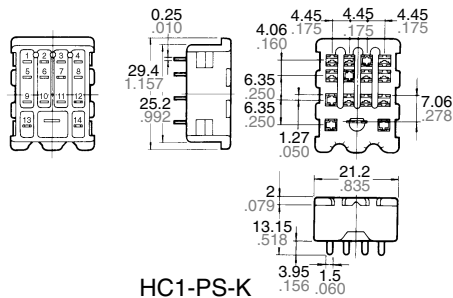

HC1-PS-K

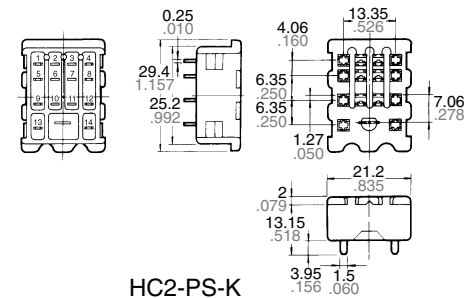

HC2-PS-K

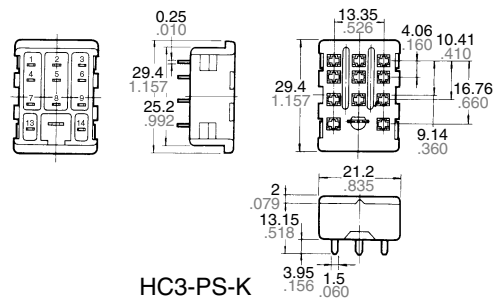

HC3-PS-K

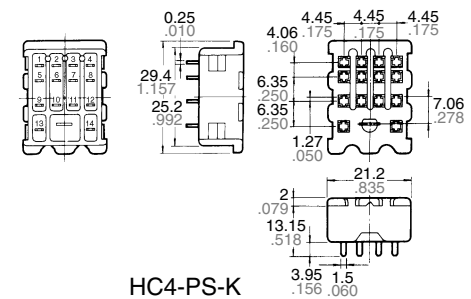

HC4-PS-K

Socket for wrapping (with hold-down clip)

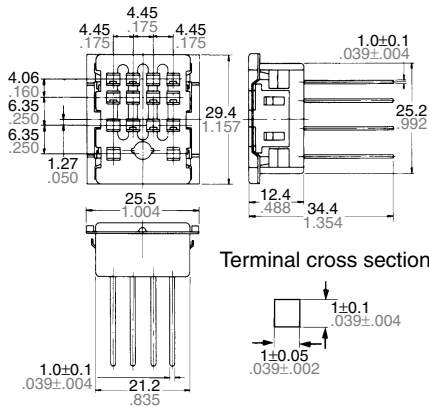

HC4-WS-K

Screw terminal socket for front wiring (with hold-down clip)

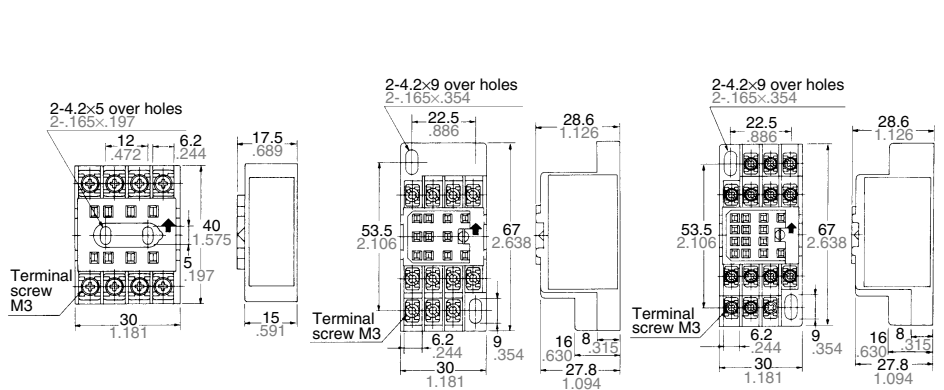

HC2-SF-K

HC3-HSF-K

HC4-HSF-K

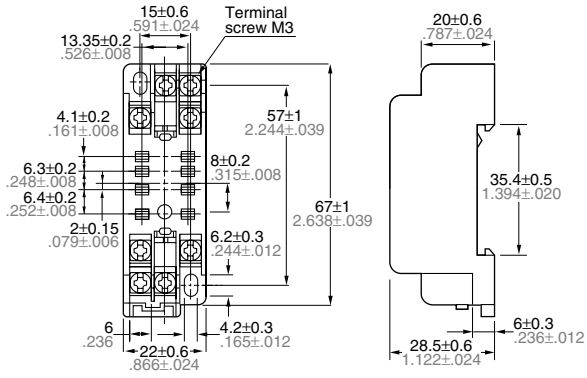

HC2-SFD-S

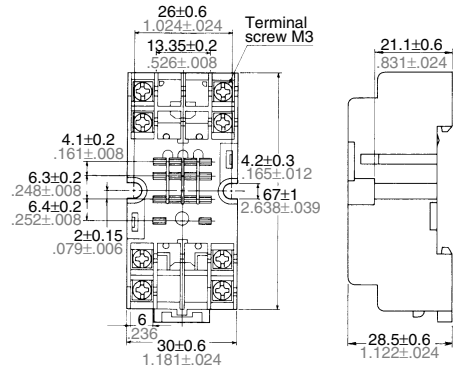

HC2-SFD-K

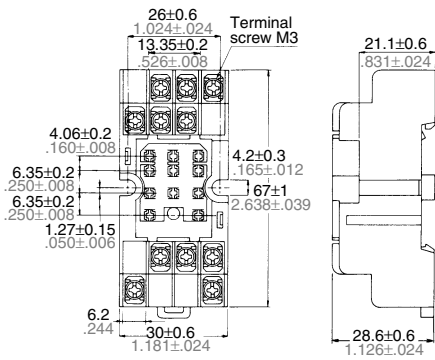

HC3-SFD-K

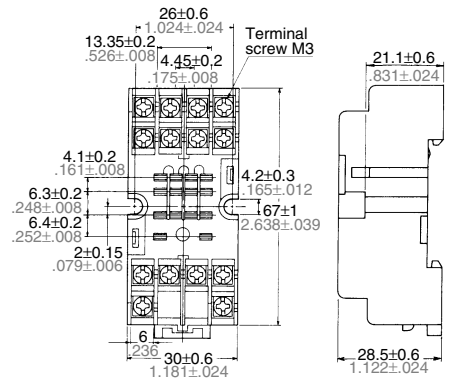

HC4-SFD-K

Hold-down clip

(1) Leaf spring: Applied to HC1-SS-K, HC2-SS-K, HC3-SS-K, HC4-SS-K, HC1-PS-K, HC2-PS-K, HC3-PS-K, HC4-PS-K, HC2-SF-K, HC3-HSF-K, HC4-HSF-K

Part No.: HC/HL-LEAF-SPRING-K

(2) "M shape" leaf spring: Applied to HC4-WS-K

Part No.: HC/HL-LEAF-SPRING-MK

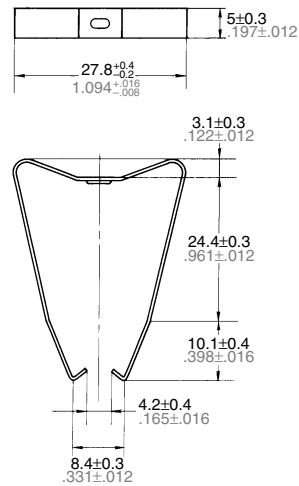
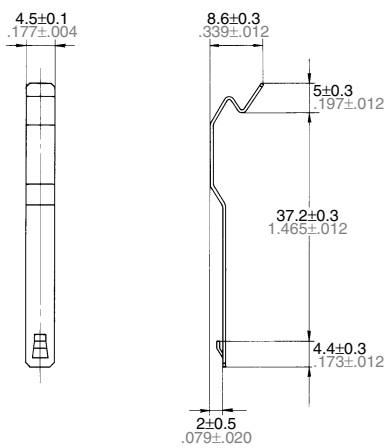

MOUNTING DIMENSIONS AND METHOD

Solder and wrapping socket mount

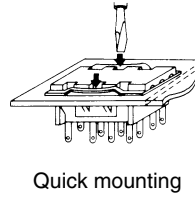
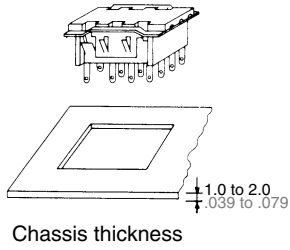

Chassis cutout

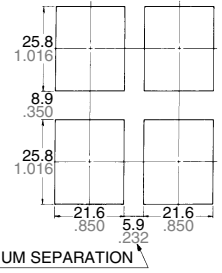

Tolerance: $\pm 0.1 \pm 0.004$

PC board pattern for PC board socket (Copper-side view)

For socket-mount

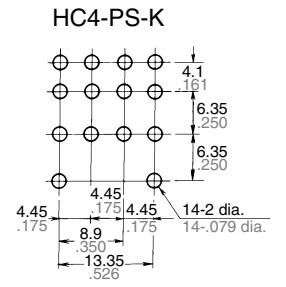
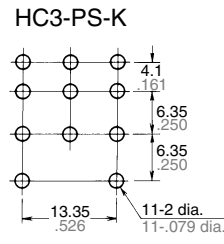
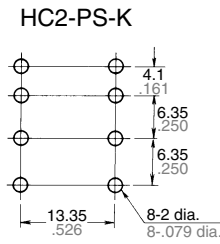
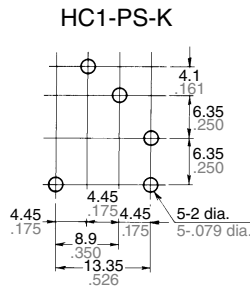

General tolerance: $\pm 0.5 \pm 0.020$

Screw socket mounts (Top view)

HC2-SF-K

Chassis cutout

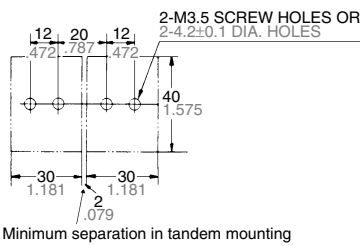

Schematic



HC3-HSF-K

Chassis cutout

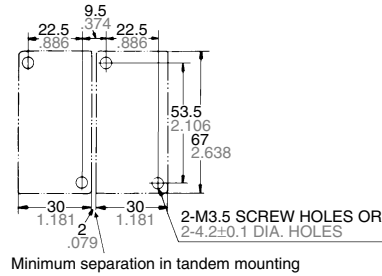

Schematic

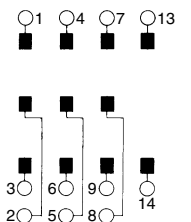

HC4-HSF-K

Chassis cutout

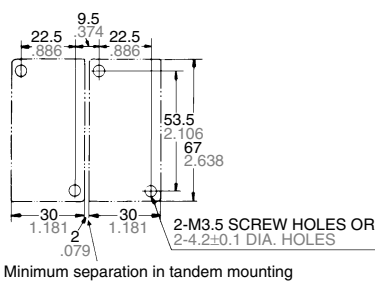

Schematic

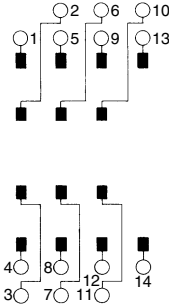

HC2-SFD-K

Chassis cutout

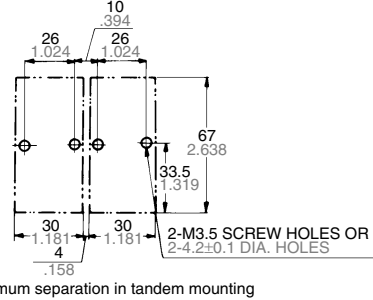

Schematic

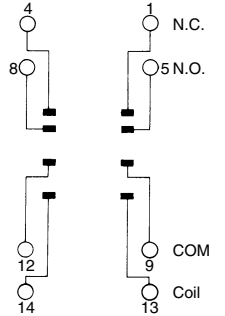

HC3-SFD-K

Chassis cutout

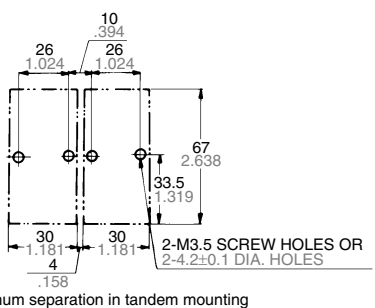

Schematic

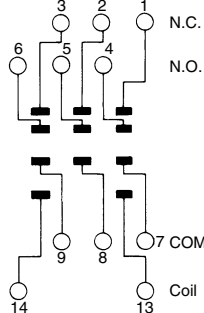

HC4-SFD-K

Chassis cutout

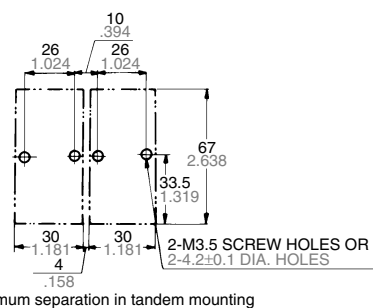

Schematic

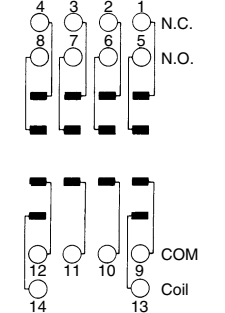

HC

Direct mount for HC-TM relay series



HC-HTM

4 Form C

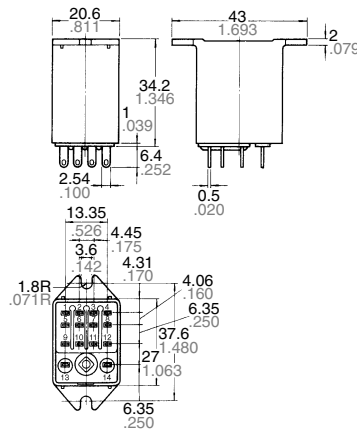

CHASSIS CUTOUT IN TANDEM MOUNTING

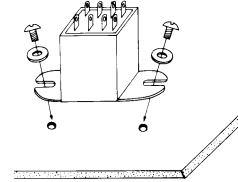
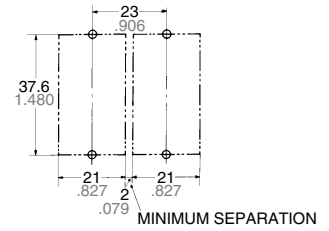

Tolerance: $\pm 0.1 \pm .004$

Notes:

1. HC 1-HTM, HC2-HTM, HC3-HTM, HC4-HTM types all have dimensions in common except for the number of terminals.
2. For the specifications, please refer to Page 297.
3. In mounting, use M3 screw and M3 washer.

Mounting track for solder socket



Up to 10 sockets per track.
Cut at notch for desired track length.

Track-mounted solder log sockets HC-MOUNTING TRACK

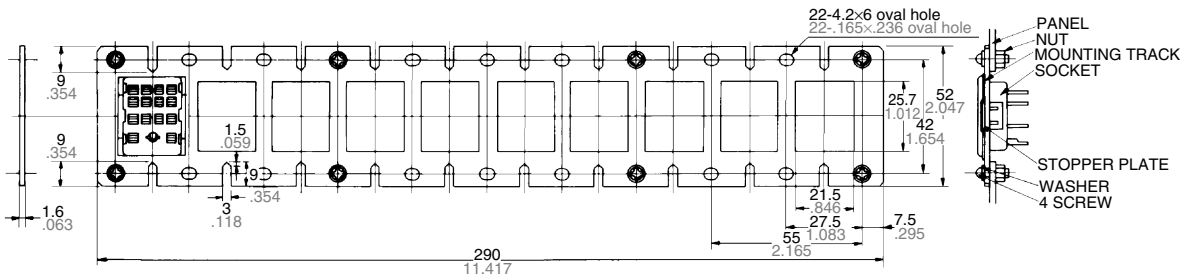

Chassis

For small quantity

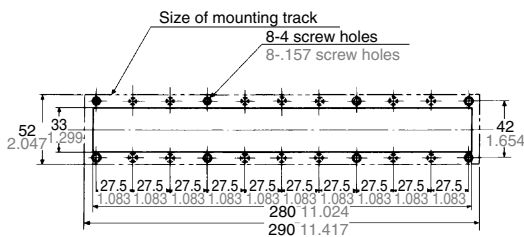

For large quantity

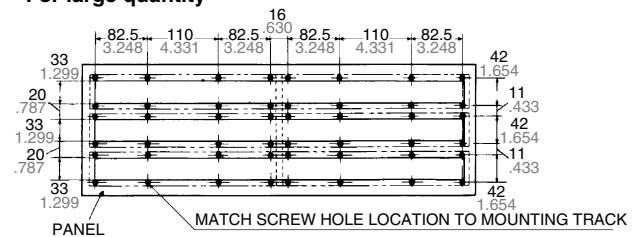

Tolerance: $\pm 0.1 \pm .004$

For Cautions for Use, see Relay Technical Information