

FEATURES

*iso*Power integrated, isolated dc-to-dc converter

Regulated 3.3 V or 5 V output

Up to 500 mW output power

16-lead SOIC package with 7.6 mm creepage

High temperature operation: 105°C maximum

Thermal overload protection

[Safety and regulatory approvals](#)

UL recognition

2500 V rms for 1 minute per UL 1577

CSA Component Acceptance Notice #5A

VDE certificate of conformity (pending)

IEC 60747-5-2 (VDE 0884, Part 2)

$V_{IORM} = 560$ V peak

APPLICATIONS

RS-232/RS-422/RS-485 transceivers

Industrial field bus isolation

Power supply startups and gate drives

Isolated sensor interfaces

Industrial PLCs

GENERAL DESCRIPTION

The ADuM5000¹ is an isolated dc-to-dc converter based on the Analog Devices, Inc., *iCoupler*[®] technology. The dc-to-dc converter in this device provides regulated, isolated power in several combinations of input and output voltages as listed in Table 1.

The Analog Devices chip scale transformer, *iCoupler* technology, transfers isolated power in this dc-to-dc converter with up to 33% efficiency. The result is a small form factor, total isolation solution.

Higher output power levels are obtained by using the ADuM5000 to augment the power output of [ADuM5401](#), [ADuM5402](#), [ADuM5403](#), [ADuM5404](#), [ADuM520x](#), and other ADuM5000 *iCouplers* with *iso*Power[®].

FUNCTIONAL BLOCK DIAGRAM

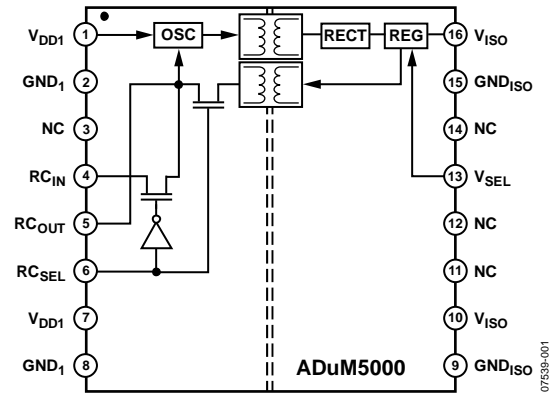

Figure 1.

*iso*Power uses high frequency switching elements to transfer power through its transformer. Special care must be taken during printed circuit board (PCB) layout to meet emissions standards. See the [AN-0971 Application Note](#) for board layout recommendations.

Table 1.

| Input Voltage (V) | Output Voltage (V) | Output Power (mW) |
|-------------------|--------------------|-------------------|
| 5 | 5 | 500 |
| 5 | 3.3 | 330 |
| 3.3 | 3.3 | 200 |

¹ Protected by U.S. Patents 5,952,849; 6,873,065; 6,903,578; and 7,075,329.

Rev. B

Information furnished by Analog Devices is believed to be accurate and reliable. However, no responsibility is assumed by Analog Devices for its use, nor for any infringements of patents or other rights of third parties that may result from its use. Specifications subject to change without notice. No license is granted by implication or otherwise under any patent or patent rights of Analog Devices. Trademarks and registered trademarks are the property of their respective owners.

ADUM5000* Product Page Quick Links

Last Content Update: 08/30/2016

Comparable Parts

View a parametric search of comparable parts

Evaluation Kits

- AD-FMCMOTCON2-EBZ Evaluation Board
- EVAL-ADUMQS
- Evaluation board for evaluating FlexMC Motor Control Low Voltage Kit
- ezLINX™ iCoupler® Isolated Interface Development Environment

Documentation

Application Notes

- AN-0971: Recommendations for Control of Radiated Emissions with isoPower Devices
- AN-727: iCoupler® Isolation in RS-485 Applications
- AN-740: iCoupler® Isolation in RS-232 Applications
- AN-770: iCoupler® Isolation in CAN Bus Applications
- AN-793: ESD/Latch-Up Considerations with iCoupler® Isolation Products
- AN-825: Power Supply Considerations in iCoupler® Isolation Products
- AN-913: Isolating I2C Interfaces

Data Sheet

- ADuM5000: 2.5 kV, Isolated DC-to-DC Converter Datasheet
- ADuM5000W: 2.5 kV, Isolated DC-to-DC Converter Data Sheet

User Guides

- UG-042: Evaluating 16-Lead SOIC and 16-Lead QSOP Digital Isolators
- UG-400: ezLINX iCoupler Isolated Interface Development Environment Hardware User Guide
- UG-461: ezLINX iCoupler Isolated Interface Development Environment Software User Guide

Tools and Simulations

- ADuM5000 IBS Models (A Grade)

Reference Designs

- CN0159
- CN0185
- CN0256
- CN0349

Reference Materials

Analog Dialogue

- Digital Isolator Simplifies USB Isolation in Medical and Industrial Applications

Press

- Analog Devices Achieves Major Milestone by Shipping 1 Billionth Channel of iCoupler Digital Isolation

Product Selection Guide

- Digital Isolator Product Selection and Resource Guide

Technical Articles

- iCoupler® Products with isoPower™ Technology: Signal and Power Transfer Across Isolation Barrier Using Microtransformers
- High Speed Digital Isolators Using Microscale On-Chip Transformers
- Inside iCoupler® Technology: ADuM347x PWM Controller and Transformer Driver with Quad-Channel Isolators Design Summary
- Micro-Transformers Provide Signal and Power Isolation for Hybrid Electric Vehicles
- MS-2204: Power Blanking for Increased Accuracy Using isoPower Devices
- MS-2488: Digital Isolation for AC Voltage Motor Drives
- NAppkin Note: Lowering the Power of the ADuM524x
- Simplify USB Isolation in Medical Applications

Design Resources

- ADUM5000 Material Declaration
- PCN-PDN Information
- Quality And Reliability
- Symbols and Footprints

Discussions

View all ADUM5000 EngineerZone Discussions

Sample and Buy

Visit the product page to see pricing options

Technical Support

Submit a technical question or find your regional support number

* This page was dynamically generated by Analog Devices, Inc. and inserted into this data sheet. Note: Dynamic changes to the content on this page does not constitute a change to the revision number of the product data sheet. This content may be frequently modified.

TABLE OF CONTENTS

| | | | |
|---|---|---|----|
| Features | 1 | Recommended Operating Conditions | 6 |
| Applications | 1 | Absolute Maximum Ratings | 7 |
| Functional Block Diagram | 1 | ESD Caution..... | 7 |
| General Description | 1 | Pin Configuration and Function Descriptions..... | 8 |
| Revision History | 2 | Typical Performance Characteristics | 9 |
| Specifications..... | 3 | Applications Information | 11 |
| Electrical Characteristics—5 V Primary Input Supply/ 5 V Secondary Isolated Supply | 3 | PCB Layout | 11 |
| Electrical Characteristics—3.3 V Primary Input Supply/ 3.3 V Secondary Isolated Supply | 3 | Start-Up Behavior..... | 11 |
| Electrical Characteristics—5 V Primary Input Supply/ 3.3 V Secondary Isolated Supply | 4 | EMI Considerations | 12 |
| Package Characteristics | 5 | Thermal Analysis | 12 |
| Regulatory Information..... | 5 | Current Limit and Thermal Overload Protection | 12 |
| Insulation and Safety-Related Specifications | 5 | Power Considerations..... | 12 |
| IEC 60747-5-2 (VDE 0884, Part 2):2003-01 Insulation Characteristics | 6 | Increasing Available Power | 13 |
| | | Insulation Lifetime | 14 |
| | | Outline Dimensions | 15 |
| | | Ordering Guide | 15 |

REVISION HISTORY

5/12—Rev. A to Rev. B

| | |
|---|---|
| Created Hyperlink for Safety and Regulatory Approvals Entry in Features Section..... | 1 |
|---|---|

11/10—Rev. 0 to Rev. A

| | |
|--|---|
| Changes to Product Title and Features Section..... | 1 |
| Changes to Table 6, Minimum External Air Gap (Clearance) Parameter, Table 7, and Minimum External Tracking (Creepage) Parameter, Table 7 | 5 |
| Changed DIN V VDE V 0884-10 (VDE V 0884-10 Insulation Characteristics Section to IEC 60747-5-2 (VDE 0884, Part 2):2003-1 Insulation Characteristics and Table Summary | 6 |
| Changes to Table 9..... | 6 |

| | |
|--|----|
| Changes to Table 10 and Table 11 | 7 |
| Changes to Pin 10, Pin 16 Description in Table 12; Changes to Table 13 | 8 |
| Changes to Figure 6 Caption and Figure 9 Caption | 9 |
| Added Figure 12 and Figure 13; Renumbered Sequentially | 10 |
| Added Start-Up Behavior Section..... | 11 |
| Changes to EMI Considerations Section and Current Limit and Thermal Overload Protection Section | 12 |
| Changes to Increasing Available Power Section..... | 12 |
| Changes to Table 14 and Table 15 | 13 |

10/08—Revision 0: Initial Version

SPECIFICATIONS

ELECTRICAL CHARACTERISTICS—5 V PRIMARY INPUT SUPPLY/5 V SECONDARY ISOLATED SUPPLY

$4.5\text{ V} \leq V_{DD1} \leq 5.5\text{ V}$, $V_{SEL} = V_{ISO}$; each voltage is relative to its respective ground. All minimum/maximum specifications apply over the entire recommended operating range, unless otherwise noted. All typical specifications are at $T_A = 25^\circ\text{C}$, $V_{DD1} = 5.0\text{ V}$, $V_{ISO} = 5.0\text{ V}$, and $V_{SEL} = V_{ISO}$.

Table 2.

| Parameter | Symbol | Min | Typ | Max | Unit | Test Conditions |
|--|-----------------|-----|-----|-----|--------|--|
| DC-TO-DC CONVERTER POWER SUPPLY | | | | | | |
| Setpoint | V_{ISO} | 4.7 | 5.0 | 5.4 | V | $I_{ISO} = 0\text{ mA}$ |
| Line Regulation | $V_{ISO(LINE)}$ | | 1 | | mV/V | $I_{ISO} = 50\text{ mA}$, $V_{DD1} = 4.5\text{ V to }5.5\text{ V}$ |
| Load Regulation | $V_{ISO(LOAD)}$ | | 1 | 5 | % | $I_{ISO} = 10\text{ mA to }90\text{ mA}$ |
| Output Ripple | $V_{ISO(RIP)}$ | | 75 | | mV p-p | 20 MHz bandwidth, $C_{BO} = 0.1\text{ }\mu\text{F} 10\text{ }\mu\text{F}$, $I_{ISO} = 90\text{ mA}$ |
| Output Noise | $V_{ISO(N)}$ | | 200 | | mV p-p | $C_{BO} = 0.1\text{ }\mu\text{F} 10\text{ }\mu\text{F}$, $I_{ISO} = 90\text{ mA}$ |
| Switching Frequency | f_{OSC} | | 180 | | MHz | |
| PWM Frequency | f_{PWM} | | 625 | | kHz | |
| I_{DD1} Supply Current, Full V_{ISO} Load | $I_{DD1(MAX)}$ | | 290 | | mA | $I_{ISO} = 100\text{ mA}$ |
| Maximum Output Supply Current | $I_{ISO(MAX)}$ | 100 | | | mA | $V_{ISO} > 4.5\text{ V}$ |
| Efficiency at Maximum Output Supply Current | | | 34 | | % | $I_{ISO} = 100\text{ mA}$ |
| I_{DD1} Supply Current, No V_{ISO} Load | $I_{DD1(Q)}$ | | 4 | 15 | mA | $I_{ISO} = 0\text{ mA}$ |
| Undervoltage Lockout, V_{DD1} and V_{ISO} Supply | | | | | | |
| Positive Going Threshold | V_{UV+} | | 2.7 | | V | |
| Negative Going Threshold | V_{UV-} | | 2.4 | | V | |
| Hysteresis | V_{UVH} | | 0.3 | | V | |

ELECTRICAL CHARACTERISTICS—3.3 V PRIMARY INPUT SUPPLY/3.3 V SECONDARY ISOLATED SUPPLY

$3.0\text{ V} \leq V_{DD1} \leq 3.6\text{ V}$, $V_{SEL} = \text{GND}_{ISO}$; each voltage is relative to its respective ground. All minimum/maximum specifications apply over the entire recommended operating range, unless otherwise noted. All typical specifications are at $T_A = 25^\circ\text{C}$, $V_{DD1} = 3.3\text{ V}$, $V_{ISO} = 3.3\text{ V}$, and $V_{SEL} = \text{GND}_{ISO}$.

Table 3.

| Parameter | Symbol | Min | Typ | Max | Unit | Test Conditions |
|--|-----------------|-----|-----|-----|--------|--|
| DC-TO-DC CONVERTER POWER SUPPLY | | | | | | |
| Setpoint | V_{ISO} | 3.0 | 3.3 | 3.6 | V | $I_{ISO} = 0\text{ mA}$ |
| Line Regulation | $V_{ISO(LINE)}$ | | 1 | | mV/V | $I_{ISO} = 30\text{ mA}$, $V_{DD1} = 3.0\text{ V to }3.6\text{ V}$ |
| Load Regulation | $V_{ISO(LOAD)}$ | | 1 | 5 | % | $I_{ISO} = 6\text{ mA to }54\text{ mA}$ |
| Output Ripple | $V_{ISO(RIP)}$ | | 50 | | mV p-p | 20 MHz bandwidth, $C_{BO} = 0.1\text{ }\mu\text{F} 10\text{ }\mu\text{F}$, $I_{ISO} = 54\text{ mA}$ |
| Output Noise | $V_{ISO(N)}$ | | 130 | | mV p-p | $C_{BO} = 0.1\text{ }\mu\text{F} 10\text{ }\mu\text{F}$, $I_{ISO} = 54\text{ mA}$ |
| Switching Frequency | f_{OSC} | | 180 | | MHz | |
| PWM Frequency | f_{PWM} | | 625 | | kHz | |
| I_{DD1} Supply Current, Full V_{ISO} Load | $I_{DD1(MAX)}$ | | 175 | | mA | $I_{ISO} = 60\text{ mA}$ |
| Maximum Output Supply Current | $I_{ISO(MAX)}$ | 60 | | | mA | $V_{ISO} > 3.0\text{ V}$ |
| Efficiency at Maximum Output Supply Current | | | 35 | | % | $I_{ISO} = 60\text{ mA}$ |
| I_{DD1} Supply Current, No V_{ISO} Load | $I_{DD1(Q)}$ | | 3 | 12 | mA | $I_{ISO} = 0\text{ mA}$ |
| Undervoltage Lockout, V_{DD1} and V_{ISO} Supply | | | | | | |
| Positive Going Threshold | V_{UV+} | | 2.7 | | V | |
| Negative Going Threshold | V_{UV-} | | 2.4 | | V | |
| Hysteresis | V_{UVH} | | 0.3 | | V | |

ELECTRICAL CHARACTERISTICS—5 V PRIMARY INPUT SUPPLY/3.3 V SECONDARY ISOLATED SUPPLY

$4.5\text{ V} \leq V_{DD1} \leq 5.5\text{ V}$, $V_{SEL} = \text{GND}_{ISO}$, each voltage is relative to its respective ground. All minimum/maximum specifications apply over the entire recommended operating range, unless otherwise noted. All typical specifications are at $T_A = 25^\circ\text{C}$, $V_{DD1} = 5.0\text{ V}$, $V_{ISO} = 3.3\text{ V}$, and $V_{SEL} = \text{GND}_{ISO}$.

Table 4.

| Parameter | Symbol | Min | Typ | Max | Unit | Test Conditions |
|--|-----------------|-----|-----|-----|--------|--|
| DC-TO-DC CONVERTER POWER SUPPLY | | | | | | |
| Setpoint | V_{ISO} | 3.0 | 3.3 | 3.6 | V | $I_{ISO} = 0\text{ mA}$ |
| Line Regulation | $V_{ISO(LINE)}$ | | 1 | | mV/V | $I_{ISO} = 50\text{ mA}$, $V_{DD1} = 4.5\text{ V to }5.5\text{ V}$ |
| Load Regulation | $V_{ISO(LOAD)}$ | | 1 | 5 | % | $I_{ISO} = 10\text{ mA to }100\text{ mA}$ |
| Output Ripple | $V_{ISO(RIP)}$ | | 50 | | mV p-p | 20 MHz bandwidth, $C_{BO} = 0.1\text{ }\mu\text{F} 10\text{ }\mu\text{F}$, $I_{ISO} = 90\text{ mA}$ |
| Output Noise | $V_{ISO(N)}$ | | 130 | | mV p-p | $C_{BO} = 0.1\text{ }\mu\text{F} 10\text{ }\mu\text{F}$, $I_{ISO} = 90\text{ mA}$ |
| Switching Frequency | f_{OSC} | | 180 | | MHz | |
| PWM Frequency | f_{PWM} | | 625 | | kHz | |
| I_{DD1} Supply Current, Full V_{ISO} Load | $I_{DD1(MAX)}$ | | 250 | | mA | $I_{ISO} = 100\text{ mA}$ |
| Maximum Output Supply Current | $I_{ISO(MAX)}$ | 100 | | | mA | $V_{ISO} > 3.0\text{ V}$ |
| Efficiency at Maximum Output Supply Current | | | 28 | | % | $I_{ISO} = 100\text{ mA}$ |
| I_{DD1} Supply Current, No V_{ISO} Load | $I_{DD1(Q)}$ | | 3 | 12 | mA | $I_{ISO} = 0\text{ mA}$ |
| Undervoltage Lockout, V_{DD1} and V_{ISO} Supply | | | | | | |
| Positive Going Threshold | V_{UV+} | | 2.7 | | V | |
| Negative Going Threshold | V_{UV-} | | 2.4 | | V | |
| Hysteresis | V_{UVH} | | 0.3 | | V | |

PACKAGE CHARACTERISTICS

Table 5.

| Parameter | Symbol | Min | Typ | Max | Unit | Test Conditions |
|--|---------------|-----|------------------|-----|-----------------------------|---|
| RESISTANCE AND CAPACITANCE | | | | | | |
| Resistance (Input-to-Output) ¹ | R_{I-O} | | 10 ¹² | | Ω | f = 1 MHz |
| Capacitance (Input-to-Output) ¹ | C_{I-O} | | 2.2 | | pF | |
| Input Capacitance ² | C_I | | 4.0 | | pF | |
| IC Junction-to-Ambient Thermal Resistance | θ_{JA} | | 45 | | $^{\circ}\text{C}/\text{W}$ | Thermocouple is located at the center of the package underside; test conducted on a 4-layer board with thin traces ³ |
| THERMAL SHUTDOWN | | | | | | |
| Thermal Shutdown Threshold | T_{SD} | | 150 | | $^{\circ}\text{C}$ | T_J rising |
| Thermal Shutdown Hysteresis | T_{SD-HYS} | | 20 | | $^{\circ}\text{C}$ | |

¹ This device is considered a 2-terminal device; Pin 1 through Pin 8 are shorted together, and Pin 9 through Pin 16 are shorted together.

² Input capacitance is from any input data pin to ground.

³ Refer to the Power Considerations section for thermal model definitions.

REGULATORY INFORMATION

The ADuM5000 is approved by the organizations listed in Table 6. Refer to Table 11 and the Insulation Lifetime section for more information about recommended maximum working voltages for specific cross isolation waveforms and insulation levels.

Table 6.

| UL | CSA | VDE (Pending) |
|--|--|--|
| Recognized under 1577 component recognition program ¹ | Approved under CSA Component Acceptance Notice #5A | Certified according to IEC 60747-5-2 (VDE 0884, Part 2):2003-01 ² |
| Single protection, 2500 V rms isolation voltage | Testing was conducted per CSA 60950-1-07 and IEC 60950-1, 2nd Edition at 2.5 kV rated voltage Basic insulation at 400 V rms (566 V peak) working voltage Reinforced insulation at 250 V rms (353 V peak) working voltage | Basic insulation, 560 V peak |
| File E214100 | File 205078 | File 2471900-4880-0001 |

¹ In accordance with UL 1577, each ADuM5000 is proof tested by applying an insulation test voltage ≥ 3000 V rms for 1 sec (current leakage detection limit = 5 μA).

² In accordance with IEC 60747-5-2 (VDE 0884, Part 2):2003-01, each ADuM5000 is proof tested by applying an insulation test voltage ≥ 1050 V peak for 1 sec (partial discharge detection limit = 5 pC). The asterisk (*) marking branded on the component designates IEC 60747-5-2 (VDE 0884, Part 2):2003-01.

INSULATION AND SAFETY-RELATED SPECIFICATIONS

Table 7.

| Parameter | Symbol | Value | Unit | Conditions |
|--|--------|-----------|-------|--|
| Rated Dielectric Insulation Voltage | | 2500 | V rms | 1-minute duration |
| Minimum External Air Gap (Clearance) | L(I01) | 8.0 | mm | Measured from input terminals to output terminals, shortest distance through air |
| Minimum External Tracking (Creepage) | L(I02) | 7.6 | mm | Measured from input terminals to output terminals, shortest distance path along body |
| Minimum Internal Distance (Internal Clearance) | | 0.017 min | mm | Distance through the insulation |
| Tracking Resistance (Comparative Tracking Index) Isolation Group | CTI | >175 | V | DIN IEC 112/VDE 0303 Part 1 Material Group (DIN VDE 0110, 1/89, Table 1) |

IEC 60747-5-2 (VDE 0884, PART 2):2003-01 INSULATION CHARACTERISTICS

This power module is suitable for reinforced electrical isolation only within the safety limit data. Maintenance of the safety data is ensured by protective circuits. The asterisk (*) marking branded on the component designates IEC 60747-5-2 (VDE 0884, Part 2):2003-01 approval.

Table 8.

| Description | Conditions | Symbol | Characteristic | Unit |
|--|--|-------------------|--|------------------|
| Installation Classification per DIN VDE 0110 For Rated Mains Voltage ≤ 150 V rms For Rated Mains Voltage ≤ 300 V rms For Rated Mains Voltage ≤ 400 V rms Climatic Classification Pollution Degree per DIN VDE 0110, Table 1 | | | I to IV I to III I to II 40/105/21 2 | |
| Maximum Working Insulation Voltage Input-to-Output Test Voltage Method b1 | $V_{IORM} \times 1.875 = V_{PRV}$, 100% production test, $t_m = 1$ sec, partial discharge < 5 pC | V_{IORM} | 560 | V peak |
| Method a After Environmental Tests Subgroup 1 After Input and/or Safety Test Subgroup 2 and Subgroup 3 | $V_{IORM} \times 1.6 = V_{PRV}$, $t_m = 60$ sec, partial discharge < 5 pC $V_{IORM} \times 1.2 = V_{PRV}$, $t_m = 60$ sec, partial discharge < 5 pC | V_{PR} | 1050 896 672 | V peak V peak |
| Highest Allowable Overvoltage Safety-Limiting Values | Transient overvoltage, $t_{TR} = 10$ sec Maximum value allowed in the event of a failure (see Figure 2) | V_{TR} | 4000 | V peak |
| Case Temperature Side 1 I_{DD1} Current | | T_S I_{S1} | 150 555 | °C mA |
| Insulation Resistance at T_S | $V_{IO} = 500$ V | R_S | >10 ⁹ | Ω |

Thermal Derating Curve

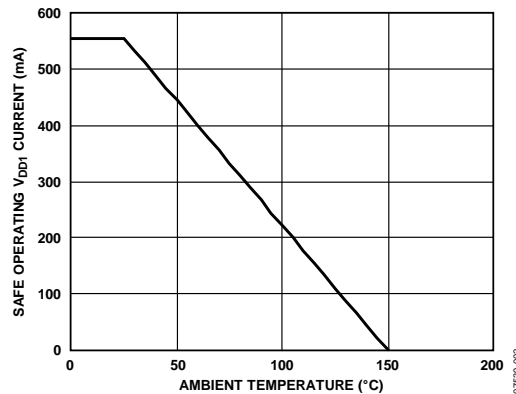

Figure 2. Thermal Derating Curve, Dependence of Safety-Limiting Values on Case Temperature, per DIN EN 60747-5-2

RECOMMENDED OPERATING CONDITIONS

Table 9.

| Parameter | Symbol | Min | Max | Unit | Comments |
|--|------------------------|------------|------------|--------|---|
| TEMPERATURE ¹ Operating Temperature | T_A | -40 | +105 | °C | |
| SUPPLY VOLTAGES ² V_{DD1} at $V_{SEL} = 0$ V V_{DD1} at $V_{SEL} = 5$ V | V_{DD1} V_{DD1} | 2.7 4.5 | 5.5 5.5 | V V | Each voltage is relative to its respective ground |

¹ Operation at 105°C requires reduction of the maximum load current as specified in Table 10.

² Each voltage is relative to its respective ground.

ABSOLUTE MAXIMUM RATINGS

Ambient temperature = 25°C, unless otherwise noted.

Table 10.

| Parameter | Rating |
|---|--------------------------------------|
| Storage Temperature (T_{ST}) | -55°C to +150°C |
| Ambient Operating Temperature (T_A) | -40°C to +105°C |
| Supply Voltages (V_{DDx} , V_{ISO}) ¹ | -0.5 V to +7.0 V |
| Input Voltage (RC_{SEL} , RC_{IN} , V_{SEL}) ^{1,2} | -0.5 V to $V_{DDI} + 0.5$ V |
| Output Voltage (RC_{OUT}) ^{1,2} | -0.5 V to $V_{DDO} + 0.5$ V |
| Average Total Output Current ³ | |
| I_{ISO} | 100 mA |
| Common-Mode Transients ⁴ | -100 kV/ μ s to +100 kV/ μ s |

¹ Each voltage is relative to its respective ground.

² V_{DDI} and V_{DDO} refer to the supply voltages on the input and output sides of a given channel, respectively. See the PCB Layout section.

³ See Figure 2 for maximum rated current values for various temperatures.

⁴ Refers to common-mode transients across the isolation barrier. Common-mode transients exceeding the absolute maximum ratings may cause latch-up or permanent damage.

Stresses above those listed under Absolute Maximum Ratings may cause permanent damage to the device. This is a stress rating only; functional operation of the device at these or any other conditions above those indicated in the operational section of this specification is not implied. Exposure to absolute maximum rating conditions for extended periods may affect device reliability.

Table 11. Maximum Continuous Working Voltage¹

| Parameter | Max | Unit | Reference Standard |
|-----------------------|-----|--------|--|
| AC Voltage | | | |
| Bipolar Waveform | 424 | V peak | 50-year minimum lifetime |
| Unipolar Waveform | | | |
| Basic Insulation | 600 | V peak | Maximum approved working voltage per IEC 60950-1 |
| Reinforced Insulation | 353 | V peak | Maximum approved working voltage per IEC 60950-1 |
| DC Voltage | | | |
| Basic Insulation | 600 | V peak | Maximum approved working voltage per IEC 60950-1 |
| Reinforced Insulation | 353 | V peak | Maximum approved working voltage per IEC 60950-1 |

¹ Refers to continuous voltage magnitude imposed across the isolation barrier. See the Insulation Lifetime section for more details.

ESD CAUTION



ESD (electrostatic discharge) sensitive device. Charged devices and circuit boards can discharge without detection. Although this product features patented or proprietary protection circuitry, damage may occur on devices subjected to high energy ESD. Therefore, proper ESD precautions should be taken to avoid performance degradation or loss of functionality.

PIN CONFIGURATION AND FUNCTION DESCRIPTIONS

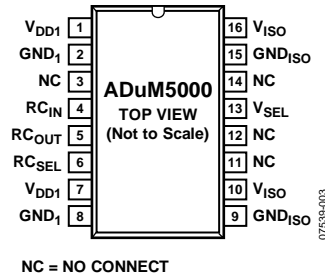

Figure 3. Pin Configuration

Table 12. Pin Function Descriptions

| Pin No. | Mnemonic | Description |
|---------------|--------------------|--|
| 1, 7 | V _{DD1} | Primary Supply Voltage 3.0 V to 5.5 V. Pin 1 and Pin 7 are internally connected to each other, and it is recommended that both pins be externally connected to a common power source. |
| 2, 8 | GND ₁ | Ground 1. Ground reference for the primary side of the converter. Pin 2 and Pin 8 are internally connected to each other, and it is recommended that both pins be connected to a common ground. |
| 3, 11, 12, 14 | NC | No Internal Connection. |
| 4 | RC _{IN} | Regulation Control Input. In slave power configuration (RC _{SEL} = low), this pin is connected to the RC _{OUT} pin of a master <i>iso</i> Power device, or tied low to disable the converter. In master/standalone mode (RC _{SEL} = high), this pin has no function. This pin is weakly pulled to low. In noisy environments, it should be tied to low or to a PWM control source. Note that this pin must not be tied high if RC _{SEL} is low; this combination causes excessive voltage on the secondary side of the converter, damaging the ADuM5000 and possibly the devices that it powers. |
| 5 | RC _{OUT} | Regulation Control Output. In master power configuration, this pin is connected to the RC _{IN} pin of a slave <i>iso</i> Power device to allow the ADuM5000 to regulate additional devices. |
| 6 | RC _{SEL} | Control Input. Sets either self-regulation/master mode (RC _{SEL} high) or slave mode (RC _{SEL} low). This pin is weakly pulled to the high state. In noisy environments, tie this pin either high or low. |
| 9, 15 | GND _{ISO} | Ground Reference for the Secondary Side of the Converter. Pin 9 and Pin 15 are internally connected to each other, and it is recommended that both pins be connected to a common ground. |
| 10, 16 | V _{ISO} | Secondary Supply Voltage Output for External Loads, 3.3 V (V _{SEL} low) or 5.0 V (V _{SEL} high). 5.0 V output functionality is not guaranteed for a 3.3 V primary supply input. Pin 10 and Pin 16 are internally connected to each other and connecting both externally is recommended. |
| 13 | V _{SEL} | Output Voltage Selection. When V _{SEL} = V _{ISO} , the V _{ISO} setpoint is 5.0 V. When V _{SEL} = GND _{ISO} , the V _{ISO} setpoint is 3.3 V. This pin is weakly pulled to high. In noisy environments, tie this pin either high or low. In slave regulation mode, this pin has no function. |

Table 13. Truth Table (Positive Logic)¹

| RC _{SEL} Input | RC _{IN} Input | RC _{OUT} Output | V _{SEL} Input | V _{DD1} Input | V _{ISO} Output | Operation |
|-------------------------|------------------------|--------------------------|------------------------|------------------------|-------------------------|--|
| H | X | PWM ² | H | 5.0 V | 5.0 V | Master mode operation, self regulating. |
| H | X | PWM ² | L | 5.0 V | 3.3 V | Master mode operation, self regulating. |
| H | X | PWM ² | H | 3.3 V | 5.0 V | This configuration is not recommended due to poor efficiency. |
| H | X | PWM ² | L | 3.3 V | 3.3 V | Master mode operation, self regulating. |
| L | RC _{OUT(EXT)} | RC _{IN} | X | X ³ | X | Slave mode, RC _{OUT(EXT)} supplied by a master <i>iso</i> Power device. |
| L | L | L | X | X | 0 V | Low power mode, converter disabled. |
| L | H | H | X | X | X | Note that this combination of RC _{IN} and RC _{SEL} is prohibited. Damage occurs on the secondary side of the converter due to excess output voltage at V _{ISO} . RC _{IN} must be low, or it must be connected to a PWM signal from a master <i>iso</i> Power part. |

¹ X = don't care.² PWM refers to the regulation control signal. This signal is derived from the secondary side regulator or from the RC_{IN} input, depending on the value of RC_{SEL}.³ V_{DD1} must be common between all *iso*Power devices being regulated by a master *iso*Power part.

TYPICAL PERFORMANCE CHARACTERISTICS

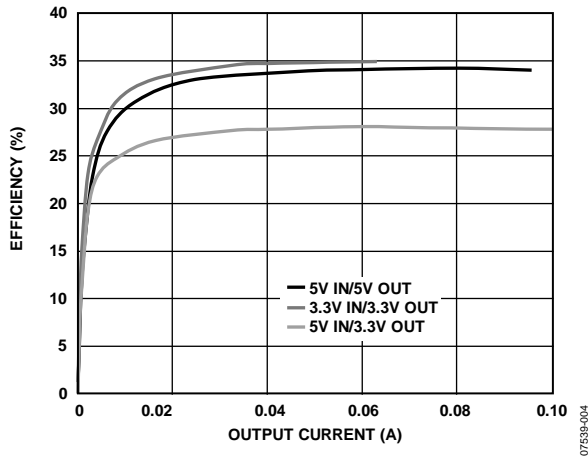

Figure 4. Typical Power Supply Efficiency in All Supported Power Configurations

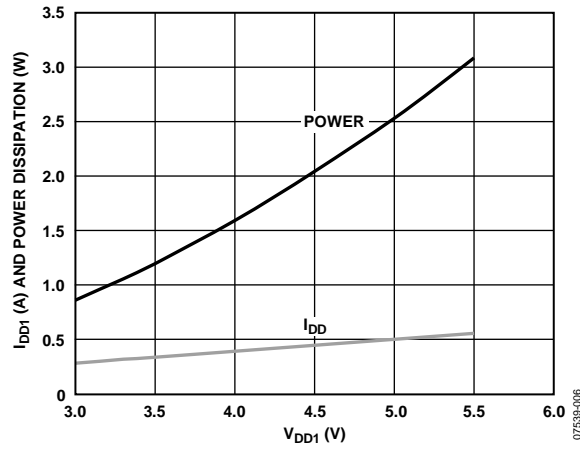

Figure 7. Typical Short-Circuit Input Current and Power vs. V_{DD1} Supply Voltage

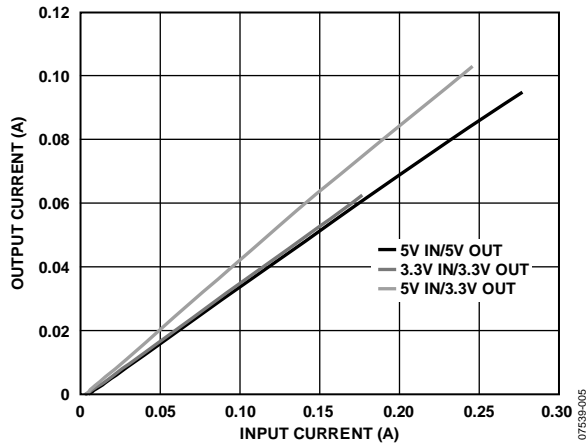

Figure 5. Typical Isolated Output Supply Current vs. External Load in All Supported Power Configurations

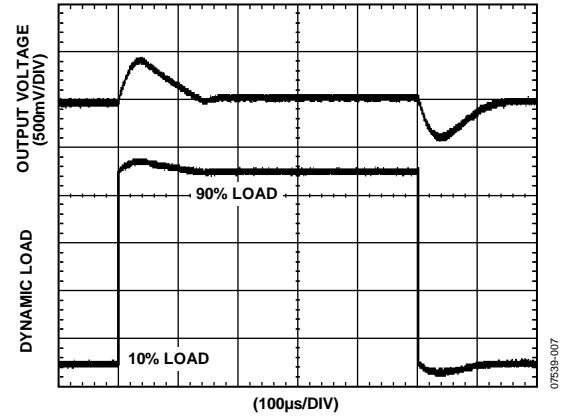

Figure 8. Typical V_{ISO} Transient Load Response, 5 V Output, 10% to 90% Load Step

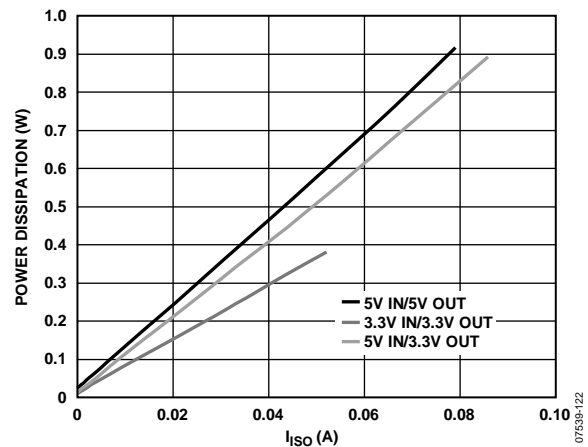

Figure 6. Typical Total Power Dissipation vs. Isolated Output Supply Current in All Supported Power Configurations

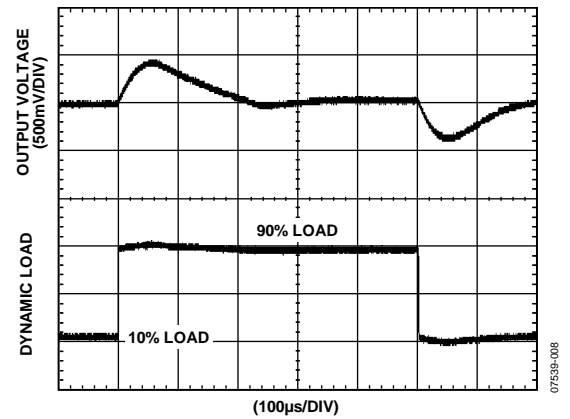

Figure 9. Typical V_{ISO} Transient Load Response, 3 V Output, 10% to 90% Load Step

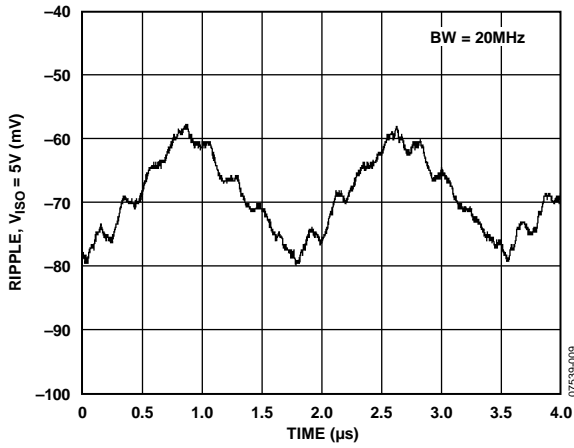

Figure 10. Typical Output Voltage Ripple at 90% Load, $V_{ISO} = 5 V$

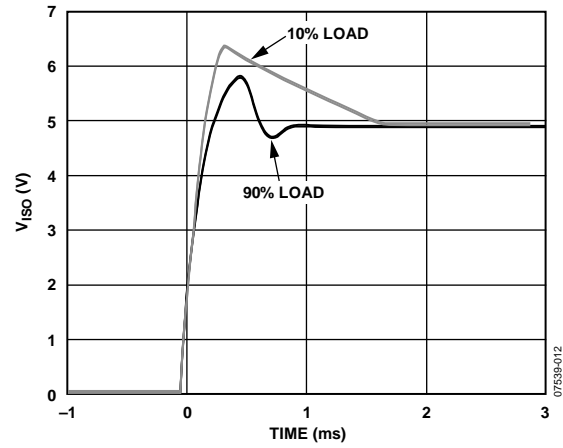

Figure 12. Typical Output Voltage Start-Up Transient at 10% and 90% Load, $V_{ISO} = 5 V$

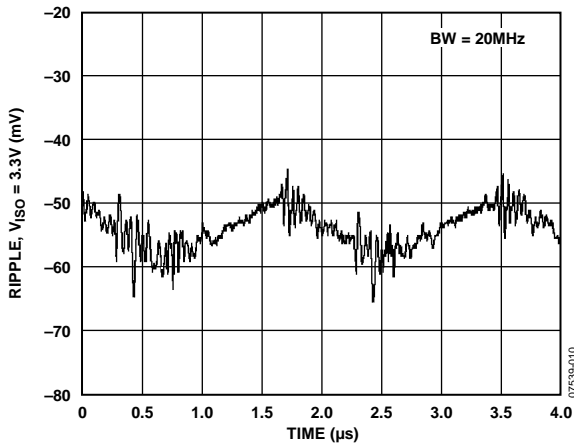

Figure 11. Typical Output Voltage Ripple at 90% Load, $V_{ISO} = 3.3 V$

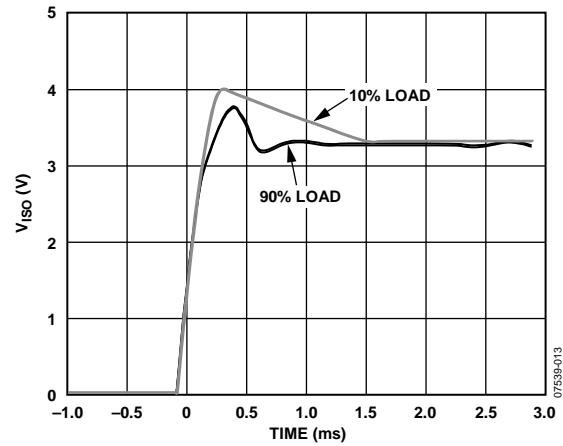

Figure 13. Typical Output Voltage Start-Up Transient at 10% and 90% Load, $V_{ISO} = 3.3 V$

APPLICATIONS INFORMATION

The dc-to-dc converter section of the ADuM5000 works on principles that are common to most switching power supplies. It has a secondary side controller architecture with isolated pulse-width modulation (PWM) feedback. V_{DD1} power is supplied to an oscillating circuit that switches current into a chip scale air core transformer. Power transferred to the secondary side is rectified and regulated to either 3.3 V or 5 V. The secondary (V_{ISO}) side controller regulates the output by creating a PWM control signal that is sent to the primary (V_{DD1}) side by a dedicated *iCoupler* data channel. The PWM modulates the oscillator circuit to control the power being sent to the secondary side. Feedback allows for significantly higher power and efficiency.

The ADuM5000 provides a regulation control output (RC_{OUT}) signal that can be connected to other *isoPower* devices. This feature allows a single regulator to control multiple power modules without contention. When auxiliary power modules are present, the V_{ISO} pins can be connected together to work as a single supply. Because there is only one feedback control path, the supplies work together seamlessly. The ADuM5000 can be a source of regulation control, as well as being controlled by another *isoPower* device.

There is an undervoltage lockout (UVLO) with hysteresis in the V_{DD1} input protection circuit. When the input voltage rises above the UVLO threshold, the dc-to-dc converter becomes active. The input voltage must be decreased below the turn-on threshold by the hysteresis value to disable the converter. This feature has many benefits in the power-up sequence of the converter, such as ensuring that the system supply rises to a minimum level before the ADuM5000 demands current. It also prevents any voltage drop due to converter current from turning the supply off and possibly oscillating.

PCB LAYOUT

The ADuM5000 digital isolator is a 0.5 W *isoPower* integrated dc-to-dc converter that requires no external interface circuitry for the logic interfaces. Power supply bypassing is required at the input and output supply pins (see Figure 14).

The power supply section of the ADuM5000 uses a 180 MHz oscillator frequency to pass power efficiently through its chip scale transformers. In addition, the normal operation of the data section of the *iCoupler* introduces switching transients on the power supply pins. Bypass capacitors are required for several operating frequencies. Noise suppression requires a low inductance, high frequency capacitor, whereas ripple suppression and proper regulation require a large value capacitor. These capacitors are most conveniently connected between Pin 1 and Pin 2 for V_{DD1} , and between Pin 15 and Pin 16 for V_{ISO} .

To suppress noise and reduce ripple, a parallel combination of at least two capacitors is required. The recommended capacitor values are 0.1 μF and 10 μF . Best practice recommends using a very low inductance ceramic capacitor, or its equivalent, for the smaller value. The total lead length between both ends of the capacitor and the input power supply pin should not exceed 10 mm. Consider bypassing between Pin 1 and Pin 8 and between Pin 9 and Pin 16 unless both common ground pins are connected together close to the package.

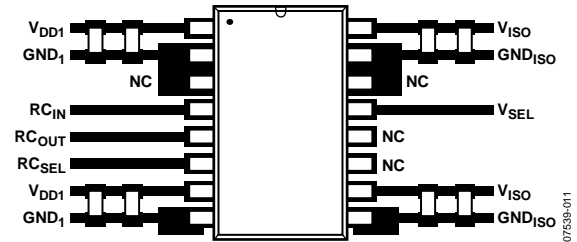

Figure 14. Recommended PCB Layout

In applications involving high common-mode transients, ensure that board coupling across the isolation barrier is minimized. Furthermore, design the board layout such that any coupling that does occur affects all pins equally on a given component side. Failure to ensure this can cause voltage differentials between pins exceeding the absolute maximum ratings for the device as specified in Table 10, thereby leading to latch-up and/or permanent damage.

The ADuM5000 is a power device that dissipates approximately 1 W of power when fully loaded. Because it is not possible to apply a heat sink to an isolation device, the device primarily depends on heat dissipation into the PCB through the GND pins. If the device is used at high ambient temperatures, provide a thermal path from the GND pins to the PCB ground plane. The board layout in Figure 14 shows enlarged pads for Pin 2 and Pin 8 (GND_1) and for Pin 9 and Pin 15 (GND_{ISO}). Implement multiple vias from the pad to the ground plane to significantly reduce the temperature inside the chip. The dimensions of the expanded pads are at the discretion of the designer and depend on the available board space.

START-UP BEHAVIOR

The ADuM5000 does not contain a soft start circuit. Take the start-up current and voltage behavior into account when designing with this device.

When power is applied to V_{DD1} , the input switching circuit begins to operate and draw current when the UVLO minimum voltage is reached. The switching circuit drives the maximum available power to the output until it reaches the regulation voltage where PWM control begins. The amount of current and time this takes depends on the load and the V_{DD1} slew rate.

With a fast V_{DD1} slew rate (200 μ s or less), the peak current draws up to 100 mA/V of V_{DD1} . The input voltage goes high faster than the output can turn on; therefore, the peak current is proportional to the maximum input voltage.

With a slow V_{DD1} slew rate (in the millisecond range), the input voltage does not change quickly when V_{DD1} reaches UVLO. The current surge is about 300 mA because V_{DD1} is nearly constant at the 2.7 V UVLO point. The behavior during start-up is similar to when the device load is a short circuit; these values are consistent with the short-circuit current shown in Figure 7.

When starting the device for $V_{ISO} = 5$ V operation, do not limit the current available to the V_{DD1} power pin to less than 300 mA. The ADuM5000 may not be able to drive the output to the regulation point if a current-limiting device clamps the V_{DD1} voltage during startup. As a result, the ADuM5000 can draw large amounts of current at low voltage for extended periods.

The output voltage of the ADuM5000 device exhibits V_{ISO} overshoot during startup. If this could potentially damage components attached to V_{ISO} , then a voltage-limiting device, such as a Zener diode, can be used to clamp the voltage. Typical behavior is shown in Figure 12 and Figure 13.

EMI CONSIDERATIONS

It is necessary for the dc-to-dc converter section of the ADuM5000 to operate at 180 MHz to allow efficient power transfer through the small transformers. This creates high frequency currents that can propagate in circuit board ground and power planes, causing edge emissions and dipole radiation between the input and output ground planes. Grounded enclosures are recommended for applications that use these devices. If grounded enclosures are not possible, follow good RF design practices in the layout of the PCB. See the [AN-0971 Application Note](#) for board layout recommendations.

THERMAL ANALYSIS

The ADuM5000 consists of four internal silicon die, attached to a split lead frame with two die attach paddles. For the purposes of thermal analysis, it is treated as a thermal unit with the highest junction temperature reflected in the θ_{JA} from Table 5. The value of θ_{JA} is based on measurements taken with the part mounted on a JEDEC standard 4-layer board with fine width traces and still air. Under normal operating conditions, the ADuM5000 operates at full load across the full temperature range without derating the output current. However, following the recommendations in the PCB Layout section decreases the thermal resistance to the PCB, allowing increased thermal margin at high ambient temperatures.

CURRENT LIMIT AND THERMAL OVERLOAD PROTECTION

The ADuM5000 is protected against damage due to excessive power dissipation by thermal overload protection circuits. Thermal overload protection limits the junction temperature to a maximum of 150°C (typical). Under extreme conditions (that is, high ambient temperature and power dissipation), when the junction temperature starts to rise above 150°C, the PWM is turned off, which turns off the output current. When the junction temperature falls below 130°C (typical), the PWM turns on again, restoring the output current to its nominal value.

Consider the case where a hard short from V_{ISO} to ground occurs. At first, the ADuM5000 reaches its maximum current, which is proportional to the voltage applied at V_{DD1} . Power dissipates on the primary side of the converter (see Figure 7). If self-heating of the junction becomes great enough to cause its temperature to rise above 150°C, thermal shutdown activates, turning off the PWM and turning off the output current. As the junction temperature cools and falls below 130°C, the PWM turns on and power dissipates again on the primary side of the converter, causing the junction temperature to rise to 150°C again. This thermal oscillation between 130°C and 150°C causes the part to cycle on and off as long as the short remains at the output.

Thermal limit protections are intended to protect the device against accidental overload conditions. For reliable operation, externally limit device power dissipation to prevent junction temperatures from exceeding 130°C.

POWER CONSIDERATIONS

The ADuM5000 converter primary side is protected from premature operation by undervoltage lockout (UVLO) circuitry. Below the minimum operating voltage, the power converter holds its oscillator inactive.

When the primary side oscillator begins to operate, it transfers power to the secondary power circuits. The secondary V_{ISO} voltage starts below its UVLO limit making it inactive and unable to generate a regulation control signal. The primary side power oscillator is allowed to free run under this condition, supplying the maximum amount of power to the secondary side.

As the secondary side voltage rises to its regulation setpoint, a large inrush current transient is present at V_{DD1} . When the regulation point is reached, the regulation control circuit produces the regulation control signal that modulates the oscillator on the primary side. The V_{DD1} current is then reduced and is proportional to the load current. The inrush current is less than the short-circuit current shown in Figure 7. The duration of the inrush depends on the V_{ISO} loading conditions and on the current and voltage available at the V_{DD1} pin.

INCREASING AVAILABLE POWER

The ADuM5000 device is designed to work in combination with other compatible *isoPower* devices. The RC_{OUT}, RC_{IN}, and RC_{SEL} pins allow the ADuM5000 to provide its PWM signal to another device through the RC_{OUT} pin acting as a master. It can also receive a PWM signal from another device through its RC_{IN} pin and act as a slave to that control signal. The RC_{SEL} pin chooses whether the part acts as a master or slave device.

When the ADuM5000 is acting as a slave, its power is regulated by the master device, allowing multiple *isoPower* parts to be combined in parallel while sharing the load equally. When the ADuM5000 is configured as a master or standalone unit, it generates its own PWM feedback signal to regulate itself and slave devices.

The ADuM5000 can function as a master, slave, or standalone device. All devices in the ADuM5xxx and ADuM6xxx family can function as standalone devices. Some of these devices also function as master devices or slave devices, but not both (see Table 14).

Table 15 shows how *isoPower* devices can provide many combinations of data channel count and multiples of the single unit power.

Table 14. Allowed Combinations of *isoPower* Parts

| Part No. | Function | | |
|----------------------|----------|-------|------------|
| | Master | Slave | Standalone |
| ADuM6000 | Yes | Yes | Yes |
| ADuM620x | No | Yes | Yes |
| ADuM640x | No | No | Yes |
| ADuM5000 | Yes | Yes | Yes |
| ADuM520x | No | Yes | Yes |
| ADuM5400 | No | No | Yes |
| ADuM5401 to ADuM5404 | Yes | No | Yes |

Another feature allowed by the RC_{SEL} and RC_{IN} control architecture is the ability to completely shut down the oscillator in the dc-to-dc converter. This places the part in a low power standby mode and reduces the current draw to a fraction of a milliamp.

When the ADuM5000 is placed in slave mode by driving RC_{SEL} low, the oscillator is controlled by RC_{IN}. If RC_{IN} is held low, the oscillator is shut down and the part is in low power standby mode. With no oscillator driving power to the secondary side, V_{ISO} turns off. This mode is useful for applications where an isolated subsystem may be shut down to conserve power. To reactivate the power module, drive RC_{SEL} high; the power supply resumes operation.

Table 15. Configurations for Power and Data Channels

| Power Units | Number of Data Channels | | |
|---------------------|---|---|---|
| | 0 Channels | 2 Channels | 4 Channels |
| 1-Unit Power | ADuM6000 or ADuM5000 (standalone) | ADuM620x or ADuM520x (standalone) | ADuM5401, ADuM5402, ADuM5403, ADuM5404, or ADuM640x (standalone) |
| 2-Unit Power | ADuM6000 or ADuM5000 (master) ADuM6000 or ADuM5000 (slave) | ADuM6000 or ADuM5000 (master) ADuM620x or ADuM520x (slave) | ADuM5401, ADuM5402, ADuM5403, ADuM5404 (master) ADuM6000 or ADuM5000 (slave) |
| 3-Unit Power | ADuM6000 or ADuM5000 (master) ADuM6000 or ADuM5000 (slave) ADuM6000 or ADuM5000 (slave) | ADuM6000 or ADuM5000 (master) ADuM6000 or ADuM5000 (slave) ADuM620x or ADuM520x (slave) | ADuM6000 or ADuM5000 (master) ADuM620x or ADuM520x (slave) ADuM620x or ADuM520x (slave) |

INSULATION LIFETIME

All insulation structures eventually break down when subjected to voltage stress over a sufficiently long period. The rate of insulation degradation is dependent on the characteristics of the voltage waveform applied across the insulation. In addition to the testing performed by the regulatory agencies, Analog Devices carries out an extensive set of evaluations to determine the lifetime of the insulation structure within the ADuM5000.

Analog Devices performs accelerated life testing using voltage levels higher than the rated continuous working voltage. Acceleration factors for several operating conditions are determined. These factors allow calculation of the time to failure at the actual working voltage. The values shown in Table 11 summarize the peak voltage for 50 years of service life for a bipolar ac operating condition, and the maximum CSA/VDE approved working voltages. In many cases, the approved working voltage is higher than 50-year service life voltage. Operation at these high working voltages can lead to shortened insulation life in some cases.

The insulation lifetime of the ADuM5000 depends on the voltage waveform imposed across the isolation barrier. The *iCoupler* insulation structure degrades at different rates depending on whether the waveform is bipolar ac, unipolar ac, or dc. Figure 15, Figure 16, and Figure 17 illustrate these different isolation voltage waveforms.

Bipolar ac voltage is the most stringent environment. The goal of a 50-year operating lifetime under the ac bipolar condition determines the maximum working voltage that Analog Devices recommends.

In the case of unipolar ac or dc voltage, the stress on the insulation is significantly lower. This allows operation at higher working voltages while still achieving a 50-year service life. The working voltages listed in Table 11 can be applied while maintaining the 50-year minimum lifetime, provided the voltage conforms to either the unipolar ac or dc voltage cases. Treat any cross insulation voltage waveform that does not conform to Figure 16 or Figure 17 as a bipolar ac waveform and limit its peak voltage to the 50-year lifetime voltage value listed in Table 11. The voltage presented in Figure 16 is shown as sinusoidal for illustration purposes only. It is meant to represent any voltage waveform varying between 0 V and some limiting value. The limiting value can be positive or negative, but the voltage cannot cross 0 V.

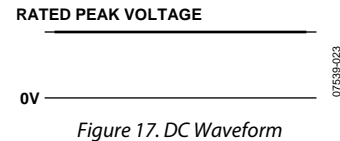
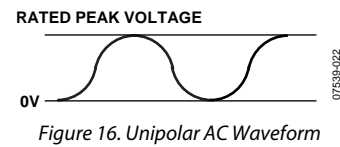
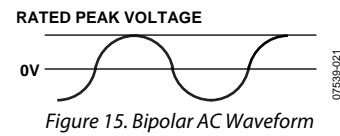

OUTLINE DIMENSIONS

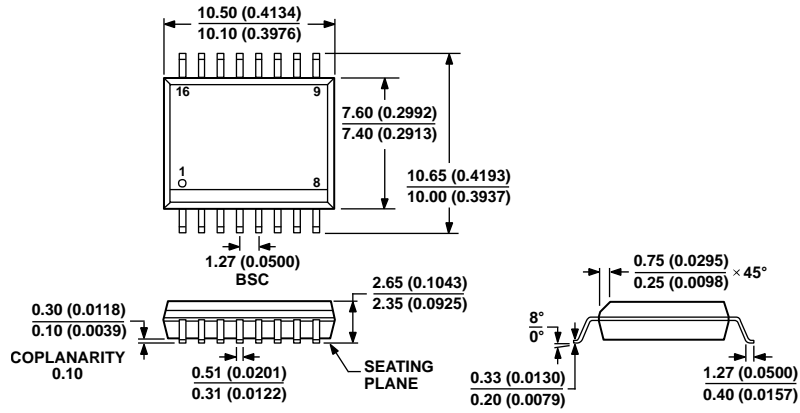

COMPLIANT TO JEDEC STANDARDS MS-013-AA
 CONTROLLING DIMENSIONS ARE IN MILLIMETERS; INCH DIMENSIONS
 (IN PARENTHESES) ARE ROUNDED-OFF MILLIMETER EQUIVALENTS FOR
 REFERENCE ONLY AND ARE NOT APPROPRIATE FOR USE IN DESIGN.

03-27-2007-B

Figure 18. 16-Lead Standard Small Outline Package [SOIC_W]
 Wide Body
 (RW-16)

Dimensions shown in millimeters and (inches)

ORDERING GUIDE

| Model ^{1,2} | Temperature Range | Package Description | Package Option |
|----------------------|-------------------|---------------------|----------------|
| ADuM5000ARWZ | -40°C to +105°C | 16-Lead SOIC_W | RW-16 |

¹ Z = RoHS Compliant Part.

² Tape and reel are available. The additional -RL suffix designates a 13-inch (1,000 units) tape and reel option.

NOTES