

T816 - X XX XX XX XX C EU

T816 Series
2.54mm pitch



Housing Color	No of Positions	Plating Options	Termination	Variation Code	C	EU:
0: Grey 1: Black	06: 6 positions : : 64: 64 positions	A1: Gold flash over 50u" Ni A2: 15u" gold over 50u" Ni A3: 30u" gold over 50u" Ni SN: Full Tin over 50u" Ni	S1: Straight THT R1: Right Angled THT	00: w/o Latch 01: Short Latch 02: Long Latch	: Fixed index	ROHS Compliant

T816-XXXXXR1XXCEU
(R/A DIP)

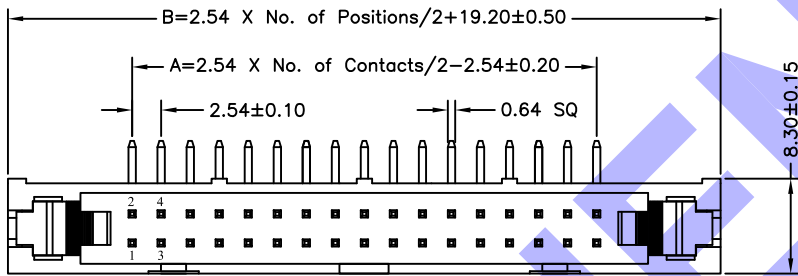

No. of PINS	Dimension Information		
	A	B	C
06	5.08	26.82	16.62
08	7.62	29.36	19.16
10	10.16	31.90	21.70
14	15.24	36.98	26.78
16	17.78	39.52	29.32
18	20.32	42.06	31.86
20	22.86	44.60	34.40
24	27.94	49.68	39.48
26	30.48	52.22	42.02
30	35.56	57.30	47.10
34	40.64	62.38	52.18
40	48.26	70.00	59.80
50	60.96	82.70	72.50
60	73.66	95.40	85.20
64	78.74	100.48	90.28

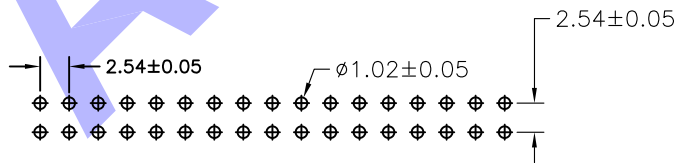
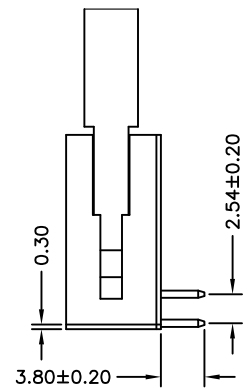
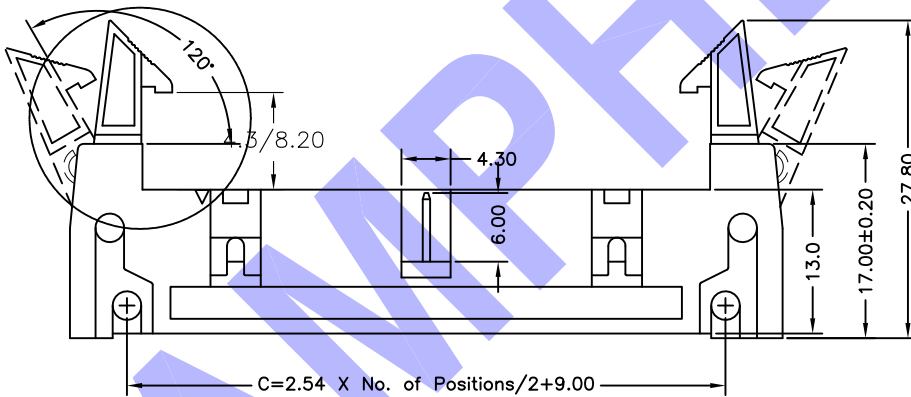

Recommended PCB Layout

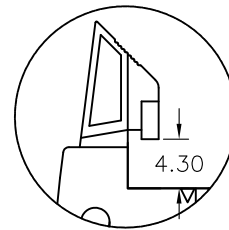

Short Latch

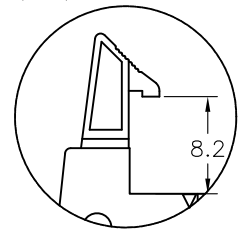

Long Latch

General Specification

Materials and Finish:
Insulator: PBT+25%G.F, UL 94V-0,
Contact: Brass, Gold or Tin Plated
 Over 50u" Ni

Electrical:
Contact Resistance: 20 mΩ max. at 1A DC
Insulation Resistance: 1000 MΩ min, at 500V/DC
Dielectric Withstanding Voltage: 500 V/AC RMS 60Hz for one minute.
Current Rating: 3.0A max.
Voltage Rating: 250V AC/RMS 60Hz, DC

Environment:
Operating Temperature:
 -40 °C to +105 °C

T816 - **X** **XX** **XX** **XX** **XX** **C** **EU**

T816 Series
2.54mm pitch



T816-XXXXXS1XXCEU
(ST DIP)

Housing Color	No of Positions	Plating Options	Termination	Variation Code	C	EU:
0: Grey 1: Black	06: 6 positions : : 64: 64 positions	A1: Gold flash over 50u" Ni A2: 15u" gold over 50u" Ni A3: 30u" gold over 50u" Ni SN: Full Tin over 50u" Ni	S1: Straight THT R1: Right Angled THT	00: w/o Latch 01: Short Latch 02: Long Latch	: Fixed index	ROHS Compliant

No. of PINS	Dimension Information		
	A	B	C
06	5.08	26.82	16.62
08	7.62	29.36	19.16
10	10.16	31.90	21.70
14	15.24	36.98	26.78
16	17.78	39.52	29.32
18	20.32	42.06	31.86
20	22.86	44.60	34.40
24	27.94	49.68	39.48
26	30.48	52.22	42.02
30	35.56	57.30	47.10
34	40.64	62.38	52.18
40	48.26	70.00	59.80
50	60.96	82.70	72.50
60	73.66	95.40	85.20
64	78.74	100.48	90.28

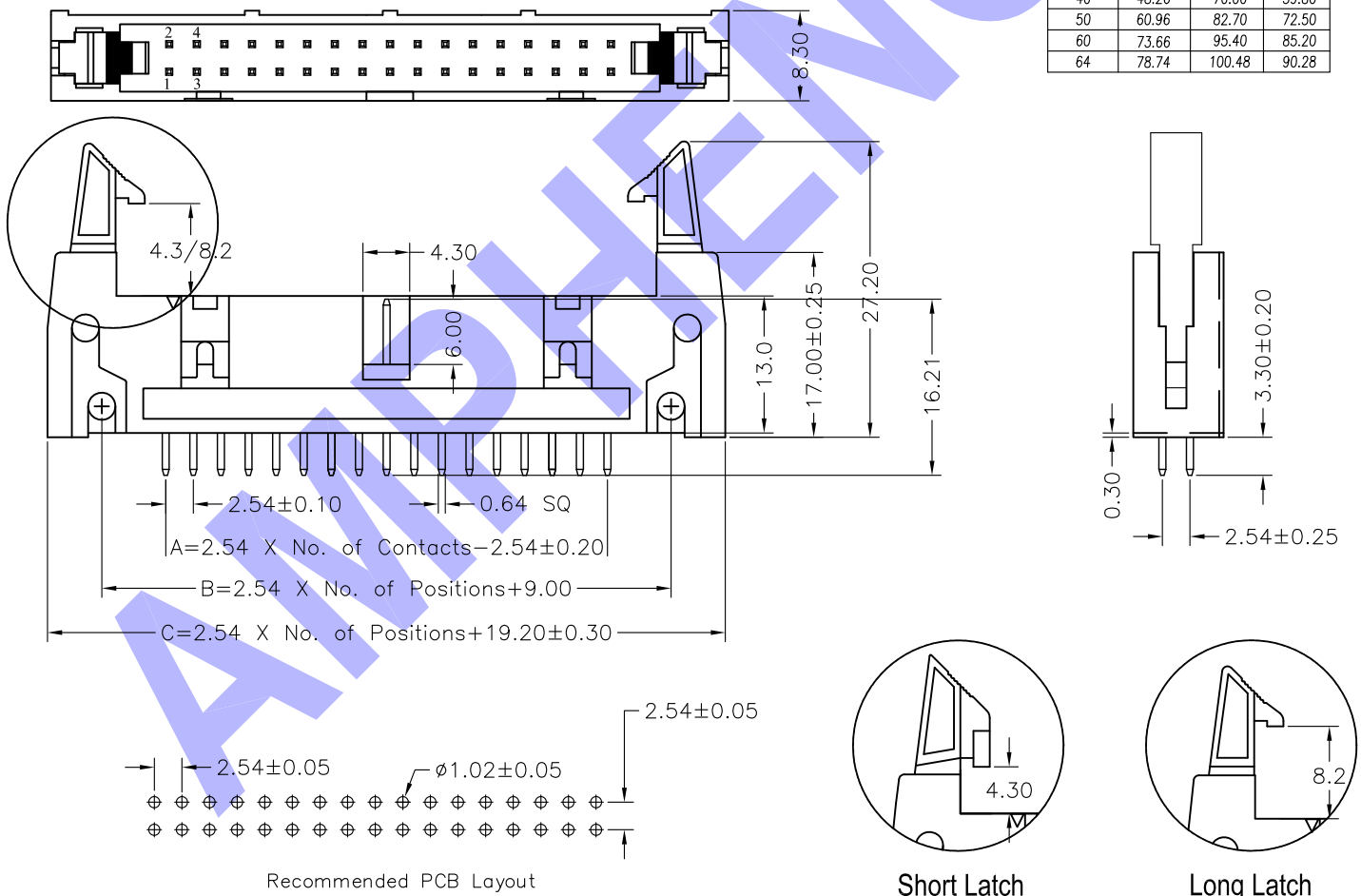

General Specification

Materials and Finish:
Insulator: PBT+25%G.F, UL 94V-0,
Contact: Brass, Gold or Tin Plated
 Over 50u" Ni

Electrical:
Contact Resistance: 20 mΩ max. at 1A DC
Insulation Resistance: 1000 MΩ min, at 500V/DC
Dielectric Withstanding Voltage: 500 V/AC RMS 60Hz for one minute.
Current Rating: 3.0A max.
Voltage Rating: 250V AC/RMS 60Hz, DC

Environment:
Operating Temperature:
 -40 °C to +105 °C