

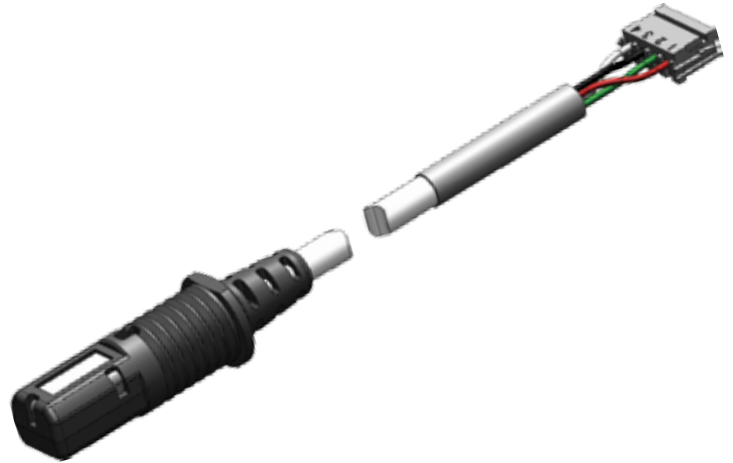

# T9602 Humidity & Temperature Sensor for OEM Installation



## Features

- Fully calibrated and temperature compensated
- Water resistant (IP 67 Certified)
- Digital or Pulse Density Modulated convertible to analogue
- Available in multiple flexible cable lengths
- Precision & accuracy ( $\pm 2\%$  RH,  $\pm 0.5^\circ\text{C}$ , 14 bit resolution)
- Low current consumption
- Designed for reliability in harsh environments
- Flexible mounting options



## Applications

- Energy saving HVAC Control – Air Conditioning, Refrigeration, Indoor Air Quality, Vent Fans, Home Appliances, Humi/Dehumidifiers
- Process Control & Instrumentation - Medical Instruments, Handheld Devices, Weather Stations, Food Processing, printers, RFID's

The T9602 offers the most advanced and cost effective humidity and temperature sensing solution for virtually any type of application.

Based on our own capacitive polymer sensor chip and ASIC integrated into an easy mount OEM package.

Each sensor is individually calibrated and tested. The T9602 is simple and ready to use without further calibration or temperature compensation.

The T9602 provides linearized output signals in one of two interfaces to meet customer requirements.

- I<sup>2</sup>C interface
- PDM output convertible to an analogue signal
- Refer to Application guide section for more detailed interfacing information

**Amphenol**  
Advanced Sensors

# Assembly Accuracy Specifications

## Relative Humidity (RH%)

Resolution	14 bit (0.01% RH)
Accuracy <sup>1</sup>	±2.0% RH (20~80% RH) ±3.5% RH (0% to 20%) and (80% to 100%) (Figure 1)
Repeatability	±0.2% RH
Hysteresis	±2.0% RH
Linearity	<2.0% RH
Response Time <sup>2</sup>	≤ 29 sec (T 63%)
Temp Coefficient	0.13% RH/°C (at 10~60°C, 10~90% RH)
Operating	0 ~ 95% RH
Long Term Drift	<0.5% RH/year (Normal conditions)

1. Accuracies measured at 25°C, nominal voltage.
2. 30% RH step response, measured at 25°C in a 1 m/sec air flow.

## Temperature (°C)

Resolution	14 bit (0.01°C)
Accuracy <sup>1</sup>	±0.5°C
Repeatability	±0.1°C
Response Time <sup>2</sup>	≤116 sec (T 63)
Operating Range <sup>3</sup>	-20°C to 70°C
Long Term Drift	<0.05°C/year (Normal conditions)

1. Accuracies measured at 25°C, nominal voltage.
2. 25°C step response in a 1 m/sec air flow.
3. Minimum design range, documented testing 0°C to 50°C.

## Typical %RH Accuracy

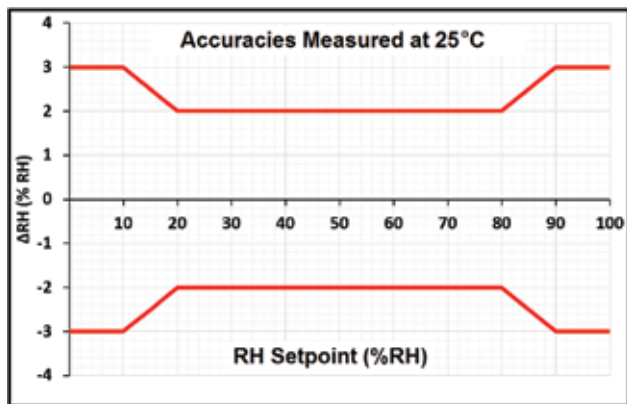

## Typical Temperature Accuracy

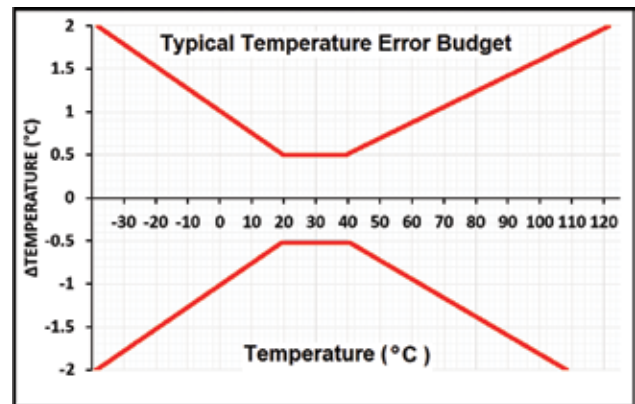

## Application Guide

Users can download Application Guide AAS-916-127 at the below link. The user will find the firmware requirements needed to interface to the digital sensors in the update mode, and the processes necessary to convert the Pulse Density Modulated (PDM) outputs to analogue outputs.

[Click here to download Application Guide AAS-916-127](#)

# Hardware and Environmental Specifications

## Method

Capacitive polymer RH Sensor, PTA (Proportional to Absolute) integrated temperature sensor.

## Operating Conditions

- -20°C to 70°C
- 0% to 100% RH

## Storage Conditions

- -40°C to 85°C

## Output Modes

- Digital Models - I<sup>2</sup>C
- Analogue Models - PDM (Convertible to analogue)

## Power Supply Requirements

- 3.3 VDC or 5.0 VDC  $\pm$ 5% (Nominal voltage is model dependent)

## Current Consumption

- 750  $\mu$ A (typical)

## Cable

- Outer Diameter  $4.20 \pm 0.20$  mm, 4 Core, shielded, double insulated and flexible
- Varying lengths dependent on the model. Refer to the ordering Information

## Connector

- Manufacturer - JST
- Sensor Connector Housing - Part Number EHR-4
- Sensor Connector Header - Part Numbers B4B-EH-A or S4B-EH

## Mounting Options

- Grommet or cable P Clamp
- P Clamp - 9.53 mm Hellermann Tyton (MPN T3D03750M4) or equivalent
- Grommet - 11 mm Advanced Antivibration Components (MPN V12R30M16004616) or equivalent.

## Approvals and Qualifications

- RoHS / REACH Compliant
- IP67 Certified
- Halogen Free Design
- Cable UL VW-1 Certified

## Warranty Terms

- 12 months

# Internal Wiring Diagrams

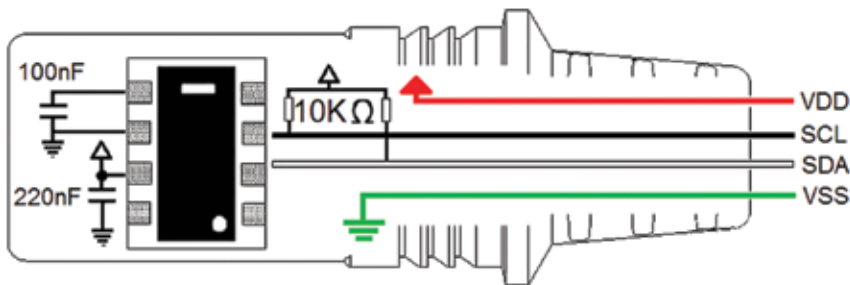

T9602 Digital Wiring Diagram

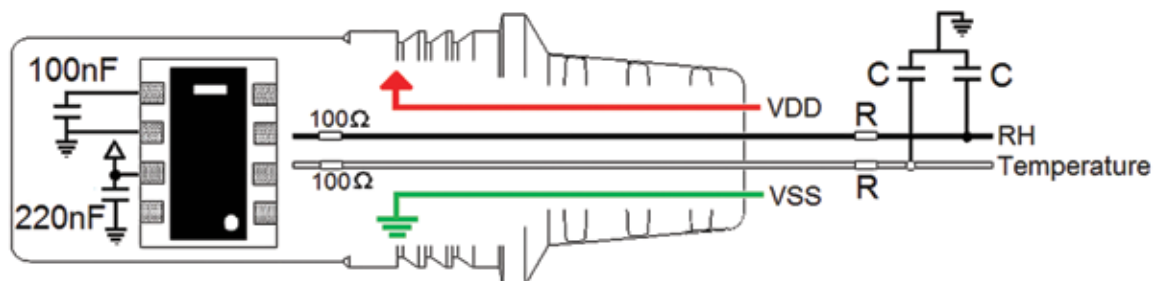

T9602 Analog Wiring Diagram

# Sensor Pin Design

## Digital

1. V+
2. Ground
3. SDA
4. SCL

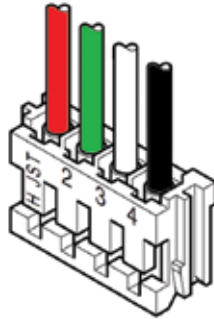

## Analogue

1. V+
2. Ground
3. PDM RH
4. PDM Temp

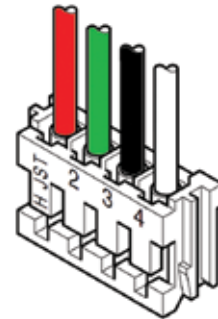

# Customer Interface Drawing

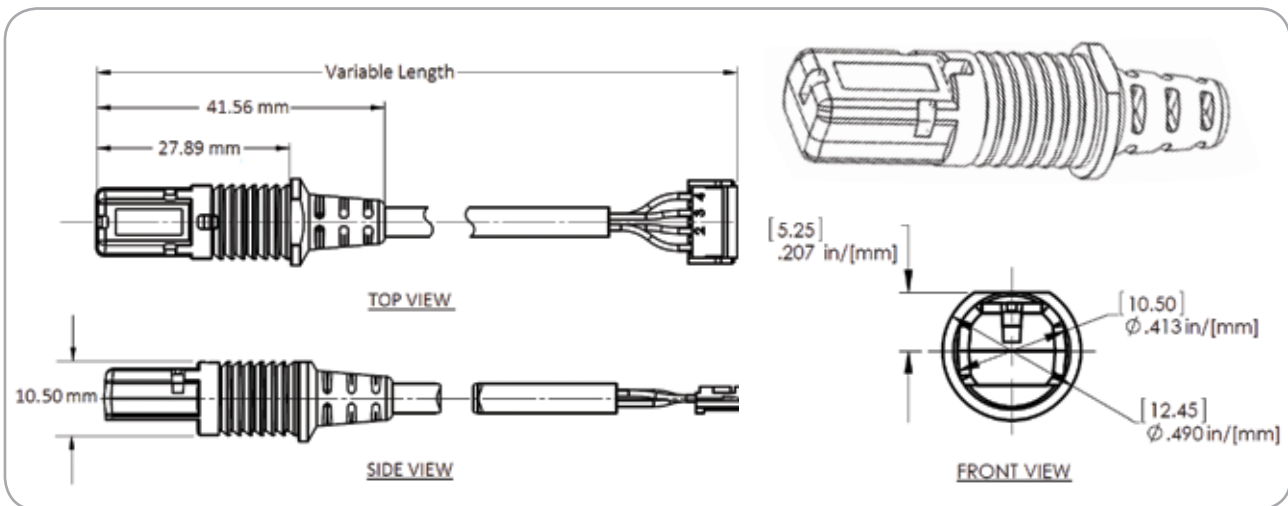

# Ordering Information

Part Number	Output	Operating Voltage	
T9602-3-D	I2C Digital	3V	1.8m cable length
T9602-5-D	I2C Digital	5V	1.8m cable length
T9602-3-D-1	I2C Digital	3V	1m cable length
T9602-5-D-1	I2C Digital	5V	1m cable length
T9602-3-A	PDM Analogue	3V	1.8m cable length
T9602-5-A	PDM Analogue	5V	1.8m cable length
T9602-3-A-1	PDM Analogue	3V	1m cable length
T9602-5-A-1	PDM Analogue	5V	1m cable length

**Amphenol**  
Advanced Sensors

[www.telaire.com](http://www.telaire.com)  
[www.amphenol-sensors.com](http://www.amphenol-sensors.com)

© 2015 Amphenol Corporation. All Rights Reserved.  
Specifications are subject to change without notice.