

REV.	ECN NO.	DATE	SIGN	DESCRIPTION
B	LEN14A0200	2014/10/14	Jinhai	Change Conn Material

Nut Plate ⑤

Screw ⑥

Sealing Nut ④

Gasket ③

Clamp Ring ②

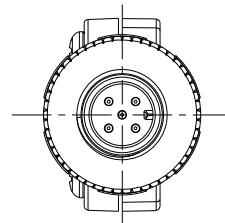
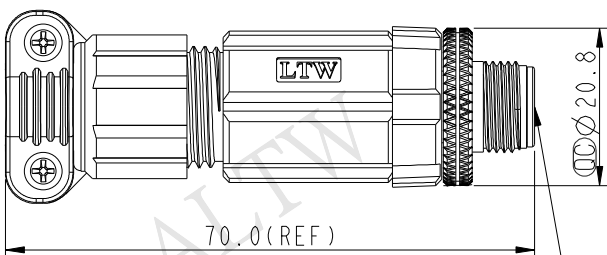

Conn.

① Connector

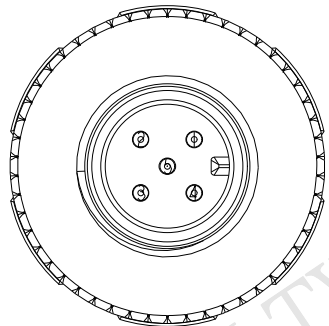
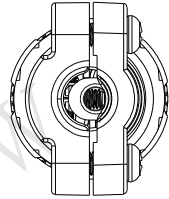
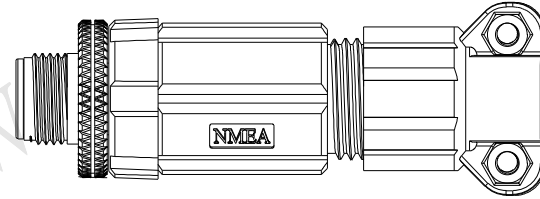
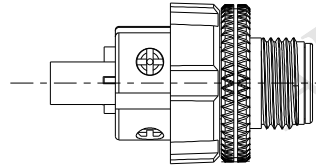
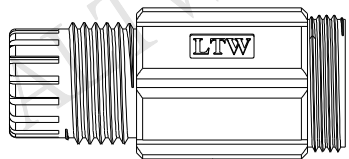

Pin Assignments
Front View

5	NET-L	Signal	Blue 藍 (24AWG)
4	NET-H	Signal	White 白 (24AWG)
3	NET-C	Power	Black 黑 (22AWG)
2	NET-S	Power	Red 紅 (22AWG)
1	Shield	Drain	Bare (22AWG)
Conn. Name	Pair	Wire Color	

Pin Out

ALTW
CONFIDENTIAL
2014-10-14
R&D DEPT.

ALTW
DCC. DEPT.
CONFIDENTIAL
2014.10.28
ISSUED

Note:

- * Ⓞ Important Dimension.
- * Waterproof Rate : IP67
- * Connector: PP, Black
- * Pin: Copper Alloy, Gold Plated
- * Holder: Nylon+GF, Black
- * Insulator: PVC, Black
- * Clamp Ring: Nylon, Black
- * Gasket: Silicone, Gray
- * Sealing Nut: Nylon, Black
- * Nut: Copper Alloy, Nickel Plated
- * Seals For Cable OD $\varnothing 4.5\text{mm} \sim \varnothing 7.5\text{mm}$
- * Temperature Range: $-20^{\circ}\text{C} \sim +70^{\circ}\text{C}$.

UNIT:mm		
TOLERANCE		
.X	± 0.25	
.XX	± 0.1	
.XXX	± 0.05	
ANGLES	$\pm 1^{\circ}$	

TITLE NMEA 2000 Micro-screw in , Male Conn Male Pin			
SCALE 1:1	SIZE A4	SHEET 1 OF 1	
REV. B	WC-REV. B.1	Ⓞ: Inspection item	

Amphenol LTW
安費諾亮泰企業股份有限公司

ITEM NO UMC-05BMMB-SL7001	DRAWN BY Jinhai	DATE 2014-10-14
DWG NO UMC-05BMMB-SL7001	CHECKED BY JZ-Li	DATE 2014-10-14
CUSTOMER ALTW	APPROVED BY Jerry	DATE 2014-10-14

THIS DOCUMENT IS SUBJECT TO CHANGE WITHOUT NOTICE. IT IS CONFIDENTIAL AND A PROPERTY OF Amphenol LTW. DISCLOSURE TO THIRD PARTY HAS TO BE AUTHORIZED BY Amphenol LTW.