

Amphenol®



UPT Connector Series

Company Overview

Manufacturing connectors for over eight decades, we take pride that Amphenol Industrial Operations (AIO) is the undisputed leader in interconnect systems for harsh environment applications. Such applications require a high degree of engineering sophistication and precision manufacturing capability. Innovations like our RADSOK® contact technology can provide up to 50% more current through the same size pin. Connectors utilizing this RADSOK® technology will outperform similar products in the market hands down.

Amphenol Industrial, a division of the Amphenol Corporation, is a leading global manufacturer of cylindrical connectors. Amphenol Industrial's product lines consist of rectangular, standard miniature, fiber optic, EMI/EMP filter, and a variety of special application connectors.

Amphenol Industrial's Sidney, NY facility, nestled at the foothills of the Catskill Mountains, is over 307,000 square feet. This complex houses over 1,000+ employees, incorporating state-of-the-art manufacturing technologies. The facility is both ISO9001 certified and qualified to MIL-STD-790 requirements.

Our manufacturing capabilities include state-of-the-art CNC machining, die-casting, molding, impact and extruding, plating, screw machining and process controls.

AIO also has a fully equipped material evaluation lab and an engineering support organization utilizing the latest in computer aided design software and analysis tools.

Our global manufacturing facilities include locations in Sidney, NY, Fraser, MI, Shenzhen and Zhuhai, China, Winnipeg, Canada, and Nogales, Mexico.

The UPT Connector Series

Amphenol Industrial has expanded its PT Series product line with a new plastic bayonet connector. The UPT provides more options for industrial interconnect markets that do not require a metal shell or Mil-Spec equivalents.

Based on the 26482 Series I, UPT is a plastic shell interconnect with a metal bayonet coupling system and crimp contacts. Featuring a light weight design, smaller footprint and easy field installation the UPT is a cost effective industrial connector solution.

- Contact Sizes and Arrangements: 12 & 16 Stamped & Formed crimp contacts, two insert arrangements available (24-32 & 24-48)
- Intermateable with Souriau TrimTrio, UTO, and ITT Trident Ringlock
- Wall Mount, Jam Nut, and Straight Plug Shell Styles
- Plastic Shell, Light Weight
- Metallic Bayonet Coupling, Molded Ring on Receptacle
- Quick Connect/Disconnect
- Multiple backshell sealing accessories
- RoHS compliant

The markets and application for the UPT connectors Included but are not limited to the following:

- Heavy Equipment
- EV, HEV, BMS
- Automation & Robotics
- Telecom Equipment
- Servo Motor
- Machinery



Technical Data	
Rated Current Contact #16	13 Amps
Rated Current Contact #12	23 Amps
Operating Voltage	250VAC
Withstanding Voltage	2000V DC
Insulation Resistance	5000 Megohms Min.
Operating Temperature	-55°~+125°
Ingress Protection	IP67(Mated)
Flammability	UL 94 V-0
Durability	500 Cycles

UPT06D-24-32S
Size 24, 32 Way, Plug

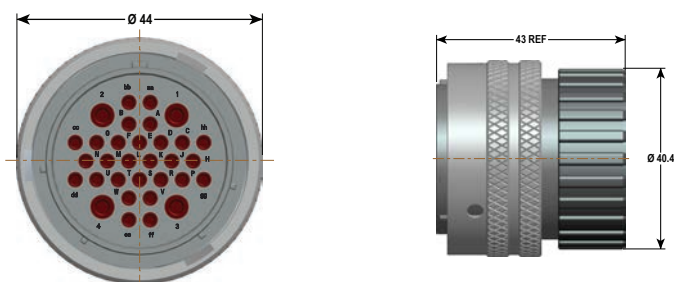

Front Face of Pin Illustrated		
Insert Arrangement	24-32	
Number of Contacts	4	28
Contact Size	12	16

UPT00D-24-32P
Size 24, 32 Way, Wall Mounting Receptacle

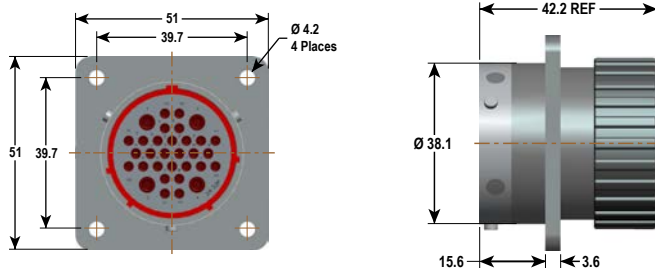

Recommended Cut-Out

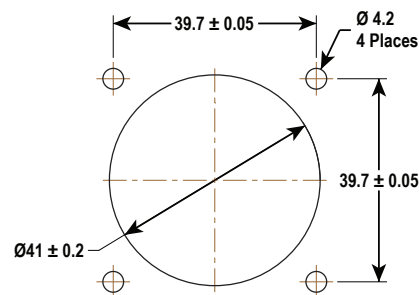

UPT07D-24-32P
Size 24, 32 Way, Jam Nut Receptacle

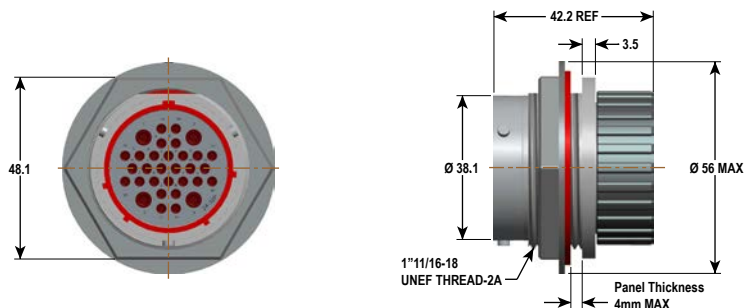

Recommended Cut-Out

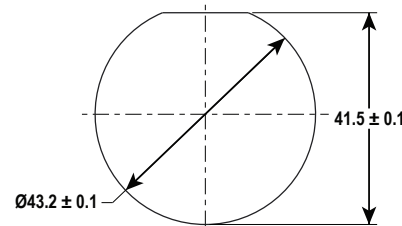

Size 24, 32 Way, Pin Contact

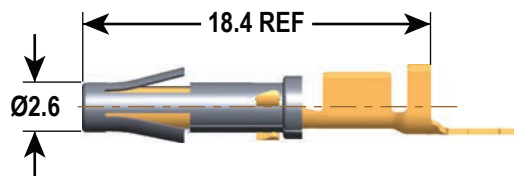
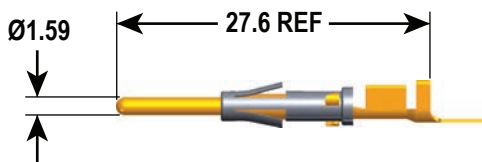
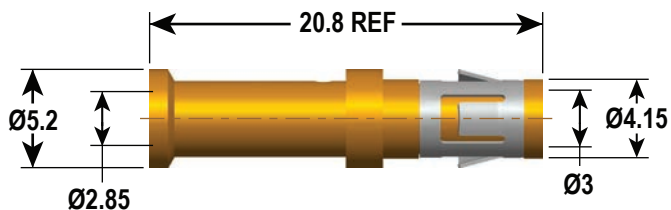
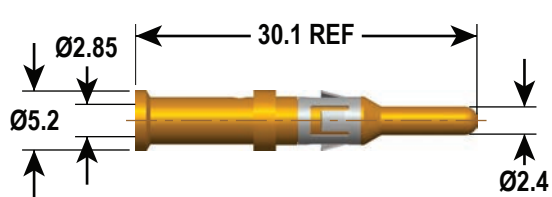

UPT06D-24-48S

Size 24, 48 Way, Plug

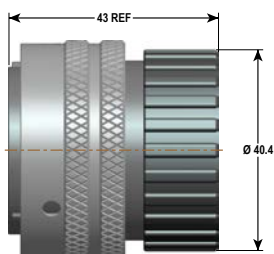
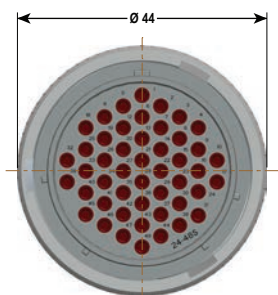

Front Face of Pin Illustrated	
Insert Arrangement	24-48
Number of Contacts	48
Contact Size	16

UPT00D-24-48P

Size 24, 48 Way, Wall Mounting Receptacle

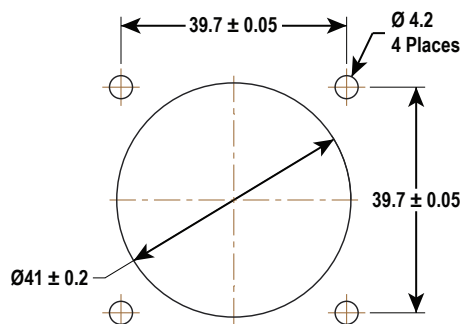
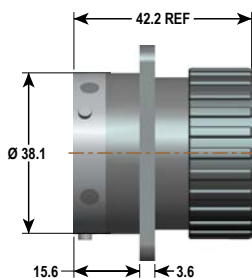
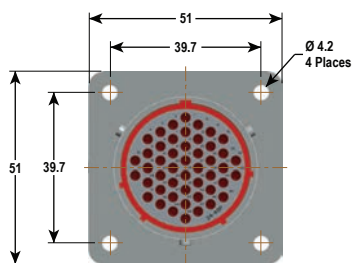



AMPHENOL CORPORATION
Amphenol Industrial

Phone: 607-563-5011
191 Delaware Avenue
Sidney, NY 13838-1395
www.amphenol-industrial.com