

Amphenol LJT MIL-DTL-38999 Series I



100% SCOOP-PROOF DESIGN WITH QUICK, POSITIVE BAYONET COUPLING

Amphenol's MIL-DTL-38999 series I LJT miniature connectors offer high-density contact arrangements and are suitable for extremely high-reliability connections, including use in military and commercial aviation. They are environmentally-sealed and have a wide operating temperature range.

- Meets requirements of HE308
- Intermateable with ITT Cannon, Deutsch, Souriau, Matrix® and all MIL-DTL-38999 series I connectors
- Formerly MIL-C-38999

APPLICATIONS

- High-performance military aircraft
- Commercial airlines
- Communications equipment
- Armored personnel carriers & tanks
- Missiles
- Shipboard
- Medical instrumentation
- High-reliability test equipment

FEATURES

QUICK-MATING

A three-point bayonet coupling system makes the LJT's quick-mating and provides an audible and tactile "click," along with visual verification of mated connectors via a sighting hole and high-visibility, bright blue bayonet pins.

SHIELDED INTERCONNECT

LJT plugs feature high-quality grounding springs that provide 360-degrees of EMI/RFI shielding protection. These springs ground the barrel of the LJT plugs to the inside wall of the LJT receptacles with a wiping action that offers effective protection from reception or transmission of electronic noise.

MANY CONTACT LAYOUTS AND STYLES

LJT connectors come in a wide variety of contact sizes and layouts, up to 128 contacts. Printed circuit board, fibre optic, thermocouple, and coax-style contacts are available for special applications.

UTILIZES HIGH-QUALITY MILITARY CONTACTS

For standard applications, LJT's come with crimp-style military contacts design to resist bending and provide reliable performance under the most rigorous conditions.

CORROSION-RESISTANT

LJT's are available with cadmium over nickel plating that has met and passed the 500-hour military salt spray corrosion tests.

TECHNICAL
SPECIFICATIONS

MATERIALS AND FINISHES

Shell	Aluminum alloy
Bayonet Pins	Passivated stainless steel per QQ-S-763
Plating	A - Clear chromate over cadmium over electroless nickel per QQ-P-416 B - Olive drab chromate over cadmium over electroless nickel per QQ-P-416 F - Electroless nickel per QQ-N-290 C - Hard, anodic, non-conductive in accordance with MIL-A-862 W52 - Olive drab zinc cobalt
Contacts	Copper alloy
Plating	Gold-plated, 50 microinches per MIL-G-45204 type II, grade C, class I
Insulator	Hard dielectric wafer which contains metal retention tines for high-reliability retention of crimp contacts
Grommet & Seals	Silicone-based elastomer
Grounding Springs	Beryllium copper

ELECTRICAL DATA

Operating Voltage & Test Voltage (Unmated Condition)	SERVICE RATING				
	TEST VOLTAGES	N	M	I	II
Sea Level	1000	1300	1800	2300	
100,000 Feet	200	200	200	200	

Current Rating by Contact Size & Wire Accommodation (Test Amps)

WIRE SIZE	22D	22M*	22*	20	16	12	8
28	1.5	1.5	-	-	-	-	-
26	2.0	2.0	2.0	-	-	-	-
24	3.0	3.0	3.0	3.0	-	-	-
22	5.0	-	5.0	5.0	-	-	-
20	-	-	-	7.5	7.5	-	-
18	-	-	-	-	10.0	-	-
16	-	-	-	-	13.0	-	-
14	-	-	-	-	-	17.0	-
12	-	-	-	-	-	23.0	-
8 (Power)	-	-	-	-	-	-	46

Contact resistance of Mated Contacts End-to-End

CONTACT SIZE	MAX. MILLIVOLT DROP
22D	73
22M*	45
22*	73
20	55
16	49
12	42
8 (Power)	26

Insulation Resistance 5,000 megohms minimum

MECHANICAL

Operating Temperature	A - Plating -65°C to 150°C (-85°F to 302°F) B - Plating -65°C to 175°C (-85°F to 347°F) F - Plating -65°C to 200°C (-85°F to 392°F) C - Anodic (non-conductive) -65°C to 200°C (-85°F to 392°F) W52 - Plating -65°C to 150°C (-85°F to 302°F)
Sealing	Against sand, dust per MIL-STD-202 & ice resistance

Wire Sealing Range	CONTACT SIZE	MINIMUM IN	MAXIMUM IN	MINIMUM MM	MAXIMUM MM
	22D	0.030	0.054	0.76	1.37
	22M*	0.030	0.050	0.76	1.27
	22*	0.034	0.060	0.86	1.52
	20	0.040	0.083	1.02	2.11
	16	0.065	0.109	1.65	2.77
	12	0.097	0.142	2.46	3.61
	10	0.135	0.162	3.42	4.12
	8 (Power)	0.135	0.155	3.43	3.94
	8 (Coax)	0.135	0.155	3.43	3.94
	8 (Twinax)	0.124	0.134	3.15	3.40

INSULATION STRIP LENGTH

CONTACT SIZE	STRIP LENGTH
22*, 22D or 22M*	.125 (3.18)
20	.188 (4.77)
16	.188 (4.77)
12	.188 (4.77)
8 (Power)	.470 (11.94)

Mating Life	500 cycles minimum																		
Salt Spray	Finish A: 48-hour per MIL-STD-1344A method 1001 condition B Finish B: 500-hour per MIL-STD 1344A method 1001 condition C Finish F: 48-hour per MIL-STD-1344A method 1001 condition B Finish C: 500-hour per MIL-STD 1344A method 1001 condition C Finish W52: 48-hour																		
Heat	Finish A: 150°C (302°F) Finish B: 175°C (347°F) Finish F: 200°C (392°F) 1000-hour to MIL-STD-1344 method 1005 Finish C: 200°C (392°F) Finish W52: 175°C (347°F)																		
Chemical Resistance	Lubricating oils, hydraulic fluids, coolants, deicing fluids per MIL-STD-1344A Method 1016 condition A-1																		
Sine Vibration	30g at ambient temperature with simulated accessory load																		
Random Vibration	49.5 grms at ambient temperatures																		
Shock	300g ±15% half-sine wave magnitude for 3 ±1 milliseconds																		
EMI-Shielding Effectiveness	100 MHz to 10 GHz - minimum attenuation of 50dB																		
Contact Type	Crimp, fibre optic, coax, twinax, or printed circuit																		
Number of Circuits	2 to 128																		
Contact Insertion	Rear-insertion/rear-extraction with simple plastic or high-quality metal hand tools.																		
Contact Retention	Per MIL-DTL-38999L tested to MIL-STD-1344A method 2007 <table border="1" style="margin-top: 5px;"> <thead> <tr> <th>CONTACT</th> <th>AXIAL LOAD NEWTONS ±10%</th> <th>AXIAL LOAD POUNDS ±10%</th> </tr> </thead> <tbody> <tr> <td>22*, 22D, 22M*</td> <td>44</td> <td>10</td> </tr> <tr> <td>20</td> <td>67</td> <td>15</td> </tr> <tr> <td>16</td> <td>111</td> <td>25</td> </tr> <tr> <td>12</td> <td>111</td> <td>25</td> </tr> <tr> <td>8 (Coax, Twinax, Power)</td> <td>111</td> <td>25</td> </tr> </tbody> </table>	CONTACT	AXIAL LOAD NEWTONS ±10%	AXIAL LOAD POUNDS ±10%	22*, 22D, 22M*	44	10	20	67	15	16	111	25	12	111	25	8 (Coax, Twinax, Power)	111	25
CONTACT	AXIAL LOAD NEWTONS ±10%	AXIAL LOAD POUNDS ±10%																	
22*, 22D, 22M*	44	10																	
20	67	15																	
16	111	25																	
12	111	25																	
8 (Coax, Twinax, Power)	111	25																	
Polarization	Three-point bayonet coupling, five keyways with optional master keyway rotations, note insert and four fixed minor keyways.																		
Approvals	MIL-DTL-38999L																		

* Inactive for new designs

CROSS-SECTION

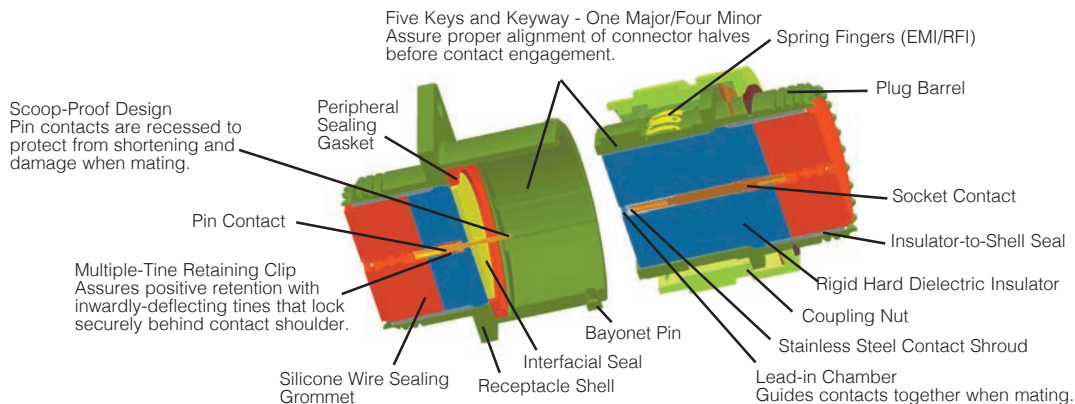

CREATE YOUR PART NUMBER

1	2	3A	4	3B	5	6	7
MS27468	T	25	F	35	P	A	-LC
SHELL STYLE	CLASS	SIZE	PLATING	LAYOUT	CONTACT	POLARIZATION (OMIT FOR NORMAL)	MODIFIER

(military part number example) *Note: Out of sequence

WHEN CHOOSING LAYOUT
First Number = Step 3A – Shell Size, Dash = Step 4 – Plating, Second Number = 3B – Layout

1	2	3	5	6	4*	7
LJT07	RE-	25-35	P	A	-014	-LC
SHELL STYLE	CLASS	LAYOUT	CONTACT	POLARIZATION (OMIT FOR NORMAL)	PLATING*	MODIFIER

(Commercial part number example)

STEP 1: SELECT SHELL STYLE, PLUG OR RECEPTACLE

RECEPTACLES ← Mates with → PLUGS



MS27466 (LJT00R)
Front Mount with Rear Accessory Threads.



MS27656 (LJTPQ00R)
Rear Mount with Rear Accessory Threads.

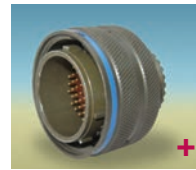

MS27467 (LJT06)

Available with PC pins. Contact us for details.



MS27496E (LJT02RE)
Front Mount without Rear Accessory Threads.

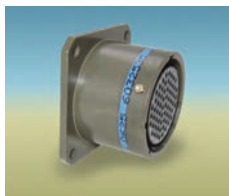

MS27505E (LJTP02RE)
Rear Mount without Rear Accessory Threads.



MS27468 (LJT07R)
Jam Nut with Rear Accessory Threads.



(LJT01R)
In-line with Accessory Threads.

STEP 2: SELECT CLASS



- E^o** = No rear accessories
- P^o** = Potting ring & cup
- T^o** = No rear accessories, NOT used on MS27505E & MS27496E
- RE** = No rear accessories
- RP** = Potting ring & cup
- RT** = No rear accessories, NOT used on LJT02RE & LJTP02RE
- RGF** = Electroless nickel-plated ground-plane aluminum 200°C
- RGW** = Olive drab cadmium-plated ground-plane aluminum

^o Military + Most Popular

STEP 3: SELECT LAYOUT

Layout	Service Rating	Contacts											Specials					
		Total	22D	22M	22	20	16	12	8	4	2/0	12*	10	8*	8**			
9-6	M	6		6														
9-35	M	6	6															
9-45	M	4			4													
9-98	I	3				3												
11-2G	I	2					2											
11-4♦	I	4				4												
11-5♦	I	5				5												
11-12(11-01)		1						1										
11-13	M	13		13														
11-35	M	13	13															
11-98	I	6				6												
11-99	I	7				7												
13-3P♦	II	3					3											
13-4G	I	4					4											
13-8	I	8				8												
13-22	M	22		22														
13-26	M	8	6					2										
13-35	M	22	22															
13-98	I	10				10												
15-4♦	I	4						4										
15-5G	II	5					5											
15-15	I	15				14	1											
15-18	I	18				18												
15-19♦	I	19				19												
15-35	M	37	37															
15-37	M	37		37														
15-68♦	I	8					8											
15-97	I	12				8	4											
17-2♦	M	39	38															1
17-6	I	6						6										
17-8G	II	8					8											
17-13♦	I	13					13											
17-22♦	COAX	4									2		2					
17-25♦	M	24	22										2					
17-26	I	26				26												
17-35	M	55	55															
17-42♦	M	42			42													
17-55	M	55		55														
17-75	I	2																2
17-99	I	23				21	2											
19-11G	II	11					11											
19-18♦	M	18	14															4
19-28		28				26	2											
19-30P♦	I	30				29	1											
19-32	I	32				32												
19-35	M	66	66															
19-53P♦	M	53			53													
19-66	M	66		66														
19-67♦♦P	M	67		67														
19-68♦♦P	I	18				18												
21-1	M	79		79														
21-2♦	M	65			65													
21-11♦G	I	11					11											
21-16G	II	16				16												
21-35	M	79		79														
21-39	I	39				37	2											
21-41	I	41				41												
21-48		4						4										
21-75♦G	N	4																(See Note 4)
21-79♦	II	19	17															(See Note 5)
23-1	M	100		100														
23-2	M	85			85													
23-6P♦G	M	6																6
23-14♦	I	14						14										
23-21G	II	21					21											
23-32P♦	I	32				32												
23-35	M	100	100															
23-53	I	53				53												
23-55♦	I	55				55												
23-P1(23-01)		1								1								
25-1	M	128		128														
25-2	M	100			100													
25-4	I	56				48	8											
25-7♦	M	99	97															2
25-11S♦	N	11				2						9						
25-19♦G	I	19						19										
25-20♦	N	30				10	13			4								3
25-24G	I	24					12	12										
25-29G	I	29					29											
25-35	M	128	128															
25-37♦♦G	I	37					37											
25-43♦	I	43				23	20											
25-46♦	I	46				40	4											(See Note 6)
25-61	I	61				61												
25-1AC(24-44)	M	8						4			4							

For listing by # of contacts, ⇨ see pages 178-181.

STEP 4: SELECT PLATING

Finish	Military	Commercial	Commercial +SR
Cadmium-plated nickel base	A	-	SR
Olive drab cadmium-plated nickel base	B	014	386
Electroless nickel	F	023	424
Electroless nickel space-compatible	-	453	467
Anodic coating (Alumilite)	C	005	300
Chromate-tested (Iridite 14-2)	-	011	344
Passivated steel (Hermetic only)	E	-	-
Stainless steel	-	155	-
Olive drab zinc cobalt	-	W52	-

SR = Strain Relief

STEP 5: SELECT CONTACT

- P = Pin
- S = Socket
- H = 1500 Mating Cycles Pin
- J = 1500 Mating Cycles Socket
- A = Less Pin Contacts
- B = Less Socket Contact

STEP 6: SELECT POLARIZATION

- N = Normal Standard (Omit for normal)
- A = Highly-Popular
- B = Limited Availability
- C = Check for Availability
- D = Check for Availability

Shell Size	N	A	B	C	D
9	95	77	-	-	113
11	95	81	67	123	109
13	95	75	63	127	115
15	95	74	61	129	116
17	95	77	65	125	113
19	95	77	65	125	113
21	95	77	65	125	113
23	95	80	69	121	110
25	95	80	69	121	110

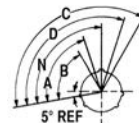

Mating Face of Receptacle

STEP 7: SELECT MODIFIER

Note: LC is not marked on part

- Omit for standard contacts
- LC = less contacts, wire hole fillers and plastic insertion/extraction tool.
- (Purchase Order must state Less Contacts)

- (4) MS Connector 21-75 is supplied with four size-8 twinax contacts. Proprietary connector 21-75 is supplied with four size-8 coax contacts.
- (5) MS connector 21-79 has provision for two size-8 coax contacts. Coax contacts are not supplied unless specified by customer.
- (6) 25-46 is supplied two size-8 coax contacts for RG180/U & RG195/U cable.

- NOT QPL'D ♦ Not Toolled for RP or 02RE P = Pin Insert Only
- * Coax ** Twinax S = Socket Insert Only
- G = Grounded

HOW TO ORDER HE308 SERIES CONNECTORS

1	2	3	4	5	6	7	8	9
HE308	07	T	1535	P	N	7	M	L
PREFIX	SHELL STYLE	CLASS	LAYOUT	CONTACT	POLARIZATION	FINISH	MANDATORY SUFFIX	MODIFIER

(military part number example)

STEP 1: SELECT SHELL STYLE, PLUG OR RECEPTACLE

RECEPTACLES

Mates with

PLUGS



00
Wall Mount Receptacle,
crimp contacts



01
Line Mount Receptacle,
crimp contacts



06
Straight Plug, crimp contacts



07
Jam Nut Receptacle,
crimp contacts



11
Jam Nut Receptacle,
PCB contacts

STEP 2: SELECT CLASS

T = Environmental with accessory thread

STEP 3: SELECT LAYOUT

For listing by # of contacts, ⇨ see pages 178-181.

LAYOUT NUMBER	SERVICE RATING	CONTACTS										SPECIALS								
		TOTAL	22D	22M	22	20	16	12	12*	10	8*	8**	8 POWER	4	00					
9-22	I	2				2														
9-35	M	6	6																	
9-98	I	3				3														
11-02	I	2					2													
11-04	I	4				4														
11-05	I	5				5														
11-01	-	1							1											
11-35	M	13	13																	
11-98	I	6				6														
11-99	I	7				7														
13-04	I	4					4													
13-08	I	8				8														
13-26	M	8	6					2												
13-35	M	22	22																	
13-98	I	10				10														
15-04	I	4						4												
15-05	II	5					5													
15-15	I	15				14	1													
15-18	I	18				18														
15-19	I	19				19														
15-35	M	37	37																	
15-97	I	12				8	4													
17-02	M	39	38											1						
17-06	I	6						6												
17-08	II	8				8														
17-25	M	24	22							2										
17-26	I	26				26														
17-35	M	55	55																	
17-75	I	2												2						
17-99	I	23				21	2													
19-11	II	11					11													
19-18	M	18	14											4						
19-28	I	28				26	2													
19-32	I	32				32														
19-35	M	66	66																	
21-11	I	11						11												
21-16	II	16					16													
21-35	M	79	79																	
21-39	I	39				37	2													
21-41	I	41				41														
21-48	-	4																	4	
21-75	N	4												(See Note 4)						
21-79	II	19	17											(See Note 5)						
23-01	M	-	1																	1
23-21	II	21					21													
23-35	M	100	100																	
23-53	I	53				53														
23-55	I	55				55														
25-04	I	56				48	8													
25-07	M	99	97											2						
25-19	I	19						19												
25-24	I	24					12	12												
25-29	I	29					29													
25-35	M	128	128																	
25-37	I	37					37													
25-43	I	43				23	20													
25-46	I	46				40	4						2							
25-61	I	61				61														
25-44	M	8					4													4

* COAX ** TWINAX

(4) MS Connector 21-75 is supplied with four size-8 twinax contacts. Proprietary connector 21-75 is supplied with four size-8 coax contacts.

(5) MS connector 21-79 has provision for two size-8 coax contacts. Coax contacts are not supplied unless specified by customer.

STEP 4: SELECT CONTACT

P = Pin S = Socket

STEP 5: SELECT POLARIZATION

- N = Normal Standard
- A = Highly-Popular
- B = Limited Availability
- C = Check for Availability
- D = Check for Availability

Mating Face of Receptacle

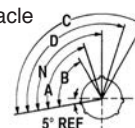

Shell Size	N	A	B	C	D
9	95	77	-	-	113
11	95	81	67	123	109
13	95	75	63	127	115
15	95	74	61	129	116
17	95	77	65	125	113
19	95	77	65	125	113
21	95	77	65	125	113
23	95	80	69	121	110
25	95	80	69	121	110

STEP 6: SELECT SHELL FINISH

- 7 = Olive drab cadmium-plated
- 6 = Electroless nickel-plated

STEP 7: MANDATORY SUFFIX

M = Mandatory Suffix

STEP 8: MODIFIER

Leave blank for connector delivered WITH contacts

L = Connector delivered WITHOUT contacts

LAYOUTS BY NUMBER OF CONTACTS

View of Mating-Face of Pin Insert

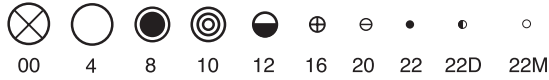

Drawing not to scale; mating face view of pin insert shown (socket view is opposite)

CONTACTS	1		2				3		4	
LAYOUT										
# OF CONTACTS	11-12	23-P1 (23-01)	9-22	11-2 +G	17-75	9-98	13-3P	9-44	11-4	
SERVICE RATING	1-#12	1-#00	2-#20	2-#16	2-#8**	3-#20	3-#16	4-#22	4-#20	
	-	-	I	I	I	I	II	M	I	
CONTACTS	4				5					
LAYOUT										
# OF CONTACTS	13-4G	15-4 +	17-22 +	21-48	21-75 +G	11-5 +	15-5G			
SERVICE RATING	4-#16	4-#12	2-#12* 2-#8* COAX	4-#8 Power	4-#8**	5-#20	5-#16			
	I	I		-	N	I	II			
CONTACTS	6				7		8			
LAYOUT										
# OF CONTACTS	9-6	9-35	11-98	17-6	23-6P+G	11-99	13-8	13-26		
SERVICE RATING	6-#22M	6-#22D	6-#20	6-#12	6-#8**	7-#20	8-#20	6-#22D, 2-#12		
	M	M	I	I	M	I	I	M		
CONTACTS	8				10		11			
LAYOUT										
# OF CONTACTS	15-68 +	17-8G	25-1A (24-44)	13-98	19-11G					
SERVICE RATING	8-#16	8-#16	4-#16, 4-#4	10-#20	11-#16					
	I	II	M	I	II					

*Coax **Twinax • NOT QPL'D + Not Tooled for RP or 02RE P = Pin Insert Only S = Socket Insert Only G = Grounded Contact us for more information.

LAYOUTS BY NUMBER OF CONTACTS

View of Mating-Face of Pin Insert



Drawing not to scale; mating face view of pin insert shown (socket view is opposite)

CONTACTS	11	12				13	
LAYOUT # OF CONTACTS SERVICE RATING	21-11 ♦ G 11-#12 I	25-11 S ♦ 2-#20, 9-#10* N	15-97 8-#20, 4-#16 I	11-13 13-#22M M	11-35 13-#22D M	17-13 ♦ 13-#16 I	
CONTACTS	14	15	16	18			
LAYOUT # OF CONTACTS SERVICE RATING	23-14 ♦ 14-#12 I	15-15 14-#20, 1-#16 I	21-16 G 16-#16 II	15-18 18-#20 I	19-18 ♦ 14-#22D, 4-#8** M		
CONTACTS	18	19			21		
LAYOUT # OF CONTACTS SERVICE RATING	19-68 P ♦ 18-#16 I	15-19 ♦ 19-#20 I	21-79 ♦ 17-#22D, 2-#8* II	25-19 ♦ G 19-#12 I	23-21 G 21-#16 II		
CONTACTS	22	23	24		26		
LAYOUT # OF CONTACTS SERVICE RATING	13-22 22-#22M M	13-35 22-#22D M	17-99 21-#20, 2-#16 I	17-25 ♦♦* 22-#22D, 2-#8 M	25-24 G 12-#16, 12-#12 I	17-26 26-#20 I	

*Coax **Twinax • NOT QPL'D ♦ Not Tooled for RP or 02RE P = Pin Insert Only S = Socket Insert Only G = Grounded Contact us for more information.

LAYOUTS BY NUMBER OF CONTACTS

View of Mating-Face of Pin Insert



Drawing not to scale; mating face view of pin insert shown (socket view is opposite)

CONTACTS	28	29	30	
LAYOUT # OF CONTACTS SERVICE RATING	19-28 26-#20, 2-#16 I	25-29G 29-#16 I	19-30P• 29-#20, 1-#16 I	25-20♦ 10-#20, 13-#16, 4-#12*, 3-#8** I
CONTACTS	32	36	37	
LAYOUT # OF CONTACTS SERVICE RATING	19-32 32-#20 I	23-32P• 32-#20 I	23-36♦ 36-#20 I	15-35 37-#22D M
15-37 37-#22M M				
CONTACTS	37	39	41	42
LAYOUT # OF CONTACTS SERVICE RATING	25-37♦G 37-#16 I	17-2♦ 38-#22D, 1-#8** M	21-39 37-#20, 2-#16 I	21-41 41-#20 I
17-42• 42-#22 M				
CONTACTS	43	46	53	
LAYOUT # OF CONTACTS SERVICE RATING	25-43♦ 23-#20, 20-#16 I	25-46♦ 40-#20, 4-#16, 2-#8** I	19-53P• 53-#22 M	23-53 53-#20 I

*Coax **Twinax • NOT QPL'D ♦ Not Tooled for RP or 02RE P = Pin Insert Only S = Socket Insert Only G = Grounded Contact us for more information.

LAYOUTS BY NUMBER OF CONTACTS

View of Mating-Face of Pin Insert



Drawing not to scale; mating face view of pin insert shown (socket view is opposite)

CONTACTS	55		56		61			
LAYOUT # OF CONTACTS SERVICE RATING	17-35 55-#22D M	17-55 55-#22M M	23-55 ♦ 55-#20 I	25-4 48-#20, 8-#16 I	25-61 61-#20 I			
CONTACTS	65		66		67		79	
LAYOUT # OF CONTACTS SERVICE RATING	21-2 ♦ 65-#22 M	19-35 66-#22D M	19-66 66-#22M M	19-67 P ♦ 67-#22M M	21-1 79-#22M M			
CONTACTS	79		85		99		100	
LAYOUT # OF CONTACTS SERVICE RATING	21-35 79-#22D M	23-2 85-#22 M	25-7 ♦ 97-#22D, 2-#8** M	23-1 100-#22M M				
CONTACTS	100				128			
LAYOUT # OF CONTACTS SERVICE RATING	23-35 100-#22D M	25-2 100-#22 M	25-1 128-#22M M	25-35 128-#22D M				

*Coax **Twinax • NOT QPL'D ♦ Not Tooled for RP or 02RE P = Pin Insert Only S = Socket Insert Only G = Grounded Contact us for more information.

CONTACTS

PINS

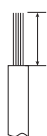

Insert head first.
Trim excess

CONTACT SIZE	WIRE SIZE AWG	PIN CONTACT PART NUMBER	COLOR BANDS			WIRE STRIP LENGTHS	WIRE RANGE		WIRE HOLE FILLER	COLOR
			1	2	3		MIN.	MAX.		
22	22,24,26 & 28	M39029/58-360	Orange	Blue	Black	.125 (3.18)	.030 (0.76)	.054 (1.37)	MS27488-22-2	Black
		M39029/107-620#	Blue	Red	Black					
22M◇	24,26 & 28	M39029/58-361	Orange	Blue	Brown	.125 (3.18)	.030 (0.76)	.050 (1.27)	MS27488-22-2	Black
22◇	22,24,& 26	M39029/58-362	Orange	Blue	Red	.125 (3.18)	.034 (0.86)	.060 (1.52)	MS27488-22-2	Black
20	20, 22 & 24	M39029/58-363	Orange	Blue	Orange	.188 (4.77)	.040 (1.02)	.083 (2.11)	MS27488-20-2	Red
		M39029/107-621#	Blue	Red	Brown					
16	16,18 & 20	M39029/58-364	Orange	Blue	Yellow	.188 (4.77)	.065 (1.65)	.109 (2.77)	MS27488-16-2	Blue
		M39029/107-622#	Blue	Red	Red					
12	12 & 14	M39029/58-365	Orange	Blue	Green	.188 (4.77)	.097 (2.46)	.142 (3.61)	MS27488-12-2	Yellow
		M39029/107-623#	Blue	Red	Orange					
10	10 & 12	M39029/58-528	Green	Red	Gray	.355 (8.51)	.135 (3.42)	.162 (4.12)	M85049/81-10	Green
8	Coax* RG180B/U RG195A/U	M39029/60-367	Orange	Blue	Violet	Detailed Instructions included with contacts	.135 (3.42)	.162 (4.12)	MS27488-8-3	Red
8	Twinax** M17/M176-0002	M39029/90-529	Green	Red	White		.124 (3.15)	.134 (3.40)	MS27488-8-3	Red
8 Power	8	10-497448-075	-	-	-	.470 (11.94)	.135 (3.42)	.162 (4.12)	MS27488-8-3	Red
8 Power	10	10-497448-095	-	-	-	.470 (11.94)	.135 (3.42)	.162 (4.12)	MS27488-8-3	Red

#1500 Mating Cycle Contacts *Coax **Twinax, contact us for details. ◇Inactive for new design For fibre optic contacts, please contact us.

SOCKETS

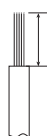

Insert head first.
Trim excess

CONTACT SIZE	WIRE SIZE AWG	PIN CONTACT PART NUMBER	COLOR BANDS			WIRE STRIP LENGTHS	WIRE RANGE		WIRE HOLE FILLER	COLOR
			1	2	3		MIN.	MAX.		
22D	22,24,26 & 28	M39029/56-348	Orange	Yellow	Gray	.125 (3.18)	.030 (0.76)	.054 (1.37)	MS27488-22-2	Black
		M39029/106-614#	Blue	Brown	Yellow					
20	20, 22 & 24	M39029/56-351	Orange	Green	Brown	.188 (4.77)	.040 (1.02)	.083 (2.11)	MS27488-20-2	Red
		M39029/106-615#	Blue	Brown	Green					
16	16,18 & 20	M39029/56-352	Orange	Green	Red	.188 (4.77)	.065 (1.65)	.109 (2.77)	MS27488-16-2	Blue
		M39029/106-616#	Blue	Brown	Blue					
12	12 & 14	M39029/56-353	Orange	Green	Orange	.188 (4.77)	.097 (2.46)	.142 (3.61)	MS27488-12-2	Yellow
		M39029/106-617#	Blue	Brown	Violet					
10	10 & 12	M39029/56-527	Green	Red	Violet	.355 (8.51)	.135 (3.42)	.162 (4.12)	M85049/81-10	Green
8	Coax* RG180B/U RG195A/U	M39029/59-366	Orange	Blue	Blue	Detailed Instructions included with contacts	.135 (3.42)	.162 (4.12)	MS27488-8-3	Red
8	Twinax** M17/M176-0002	M39029/91-530	Green	Orange	Black		.124 (3.15)	.134 (3.40)	MS27488-8-3	Red
8 Power	8	10-497446-075	-	-	-	.470 (11.94)	.135 (3.42)	.162 (4.12)	MS27488-8-3	Red
8 Power	10	10-497446-095	-	-	-	.470 (11.94)	.135 (3.42)	.162 (4.12)	MS27488-8-3	Red

#1500 Mating Cycle Contacts *Coax **Twinax, contact us for details. ◇Inactive for new design For fibre optic contacts, please contact us.

PINS

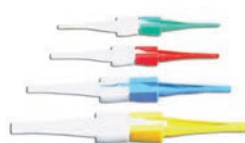

CONTACT SIZE	HAND-CRIMP TOOL	POWER-CRIMP TOOL	TURRET HEADS	USE LOCATOR COLOR	PLASTIC INSERTION/ EXTRACTAION TOOL	INSERTION TIP COLOR	EXTRACTION TIP COLOR	METAL INSERTION TOOL	COLOR BAND	METAL EXTRACTION TOOL	COLOR BAND	
											1	2
22D	M22520/2-01	WA22††	M22520/2-09	-	M81969/14-01	Green	White	MS27495A22M	Black	MS27495R22M	Black	White
22M◇	M22520/2-01	WA22††	M22520/2-09	-	M81969/14-01	Green	White	MS27495A22M	Black	MS27495R22M	Black	White
22◇	M22520/2-01	WA22††	M22520/2-09	-	M81969/14-01	Green	White	MS27495A22	Black	MS27495R22M	Black	White
20	M22520/1-01	WA27F††	M22520/1-04	Red	M81969/14-10	Red	Orange	MS27495A20	Blue	MS27495R16	Blue	White
16	M22520/1-01	WA27F††	M22520/1-04	Blue	M81969/14-03	Blue	White	MS27495A16	Green	M81969/8-12	Green	White
12	M22520/1-01	WA27F††	M22520/1-04	Yellow	M81969/14-04	Yellow	White	DAK95-12B	--	DRK95-12B	-	-
10	TP-201423 or 1716P-1	-	-	-	M81969/14-05	Gray	White	M81969/8-11	Green	M81969/8-12	Green	White
8 Coax	M22520/2-01 M22520/5-01	WA22†† HX23	M22520/2-31 (inner) M22520/5-05 (outer)		M81969/14-12	Green		-	-	DRK264-8	-	-
8 Twinax	M22520/2-01 M22520/5-01	WA22†† HX23	K709 (inner) Y631 (outer)		M81969/14-12	Green		M81969/46-06	Red	M81969/46-12	-	-
8 Power	-	400B-1	414DA-8N(Die) 4691 (positioner)	-	M81969/14-12 (extraction only)	-	Green	-	-	DRK264-8	-	-
8 Power	M3SP-6	400B-1	414DA-10N(Die) 4691 (positioner)	-	M81969/14-12 (extraction only)	-	Green	-	-	DRK264-8	-	-

†† Contact us for more tool accessories.

SOCKETS



CONTACT SIZE	HAND-CRIMP TOOL	POWER-CRIMP TOOL	TURRET HEADS	USE LOCATOR COLOR	PLASTIC INSERTION/ EXTRACTAION TOOL	INSERTION TIP COLOR	EXTRACTION TIP COLOR	METAL INSERTION TOOL	COLOR BAND	METAL EXTRACTION TOOL	COLOR BAND	
											1	2
22D	M22520/2-01	WA22††	M22520/2-09	-	M81969/14-01	Green	White	MS27495A22M	Black	MS27495R22M	Black	White
20	M22520/1-01	WA27F††	M22520/1-04	Red	M81969/14-10	Red	Orange	MS27495A20	Blue	MS27495R16	Blue	White
16	M22520/1-01	WA27F††	M22520/1-04	Blue	M81969/14-03	Blue	White	MS27495A16	Green	M81969/8-12	Green	White
12	M22520/1-01	WA27F††	M22520/1-04	Yellow	M81969/14-04	Yellow	White	DAK95-12B	--	DRK95-12B	-	-
10	TP-201423 or 1716P-1	-	-	-	M81969/14-05	Gray	White	M81969/8-11	Green	M81969/8-12	Green	White
8 Coax	M22520/2-01 M22520/5-01	WA22†† HX23	M22520/2-31 (inner) M22520/5-05 (outer)		M81969/14-12	Green		-	-	DRK264-8	-	-
8 Twinax	M22520/2-01 M22520/5-01	WA22†† HX23	K709 (inner) Y631 (outer)		M81969/14-12	Green		M81969/46-06	Red	M81969/46-12	-	-
8 Power	-	400B-1	414DA-8N(Die) 4691 (positioner)	-	M81969/14-12 (extraction only)	-	Green	-	-	DRK264-8	-	-
8 Power	M3SP-6	400B-1	414DA-10N(Die) 4691 (positioner)	-	M81969/14-12 (extraction only)	-	Green	-	-	DRK264-8	-	-

†† Contact us for more tool accessories.

COAX CONTACTS



M22520/5-01

Crimp Dies

COAX CONTACT SIZE	CABLE TYPE	CONTACT PART NUMBER		CRIMPING TOOLS	
		PIN	SOCKET	INNER CONTACT	CRIMP FERRULE
16	RG-178B/U, RG-196A/U	21-033122-564 (M39029/76-425)	21-033123-564 (M39029/77-429)	M22520/2-01 w/ Positioner M22520/2-35 or w/ Daniels Positioner K532	M22520/4-01 w/ Positioner M22520/4-02
	RG-174A/U, RG-188A/U, RG-161/U, RG-187A/U, RG-316/U, RG-179B/U	21-033122-563 (M39029/76-424)	21-033123-563 (M39029/77-428)		
12	RG-180B/U, RG-195A/U	21-033122-546 (M39029/28-211)	21-033123-546 (M39029/75-416)	M22520/2-01 w/ Positioner M22520/2-34 or w/ Daniels Positioner K323	M22520/31-01 w/ Positioner M22520/31-02 or Daniels GS-200 Tool w/ Positioner G2P330
	RG-187A/U, RG-179B/U, RG-174A/U, RG-188A/U, RG-316/U, RG-161/U	21-033122-541 (M39029/28-409)	21-033123-541 (M39029/75-417)		
8	RG-187A/U, RG-179B/U, RG-174A/U, RG-188A/U, RG-316/U, RG-161/U	21-033102-023	21-033101-023	M22520/2-01 w/ Positioner M22520/2-31 or Solder	M22520/5-01 w/ die set M22520/5-03 (A) or M22520/5-08 (A) M22520/5-35 (B) or M22520/10-01 w/ die set M22520/10-05 (A)
	RG-142B/U, RG-223/U	21-033102-024	21-033101-024	Solder	M22520/5-01 w/ die set M22520/5-05 (A) or M22520/5-19 (B) or M22520/10-01 w/ die set M22520/10-07 (A)
	RG-180B/U, RG-195A/U	21-033102-021 (M39029/60-367)	21-033101-021 (M39029/59-366)	M22520/2-01 w/ Positioner M22520/2-31 or Solder	M22520/5-01 w/ die set M22520/5-05 (B) or M22520/5-41 (B) or M22520/10-01 w/ die set M22520/10-07 (B)
	RG-400	21-033102-027	21-033101-027	M22520/2-01 w/ Positioner M22520/2-10	M22520/5-01 w/ die set M22520/5-45 (A)
	RG-58 (M17/155-00001)	21-033102-029	21-033101-029	Solder	M22520/5-01 w/ die set M22520/5-05 (B)

PRINTED CIRCUIT BOARD CONTACTS - PIN

PCB PIN CONTACTS	SIZE	TAIL DIAMETER +/- .001	CONTACT STICKOUT MAX./MIN.						
			MS27466 LJT00RT	MS27656 LJTPQ00RT	MS27496 LJT02RE	MS27505 LJTP02RE	MS27467 LJT06RE	MS27468 LJT07RE	
								(9-17)	(19-25)
10-407552-015	22M	0.019	.372 / .317	.357 / .302	.576 / .521	.576 / .520	.372 / .317	.351 / .296	.329 / .279
10-407552-055	22M	0.019	.261 / .206	.246 / .191	.465 / .410	.465 / .409	.261 / .206	.240 / .185	.218 / .168
10-407552-085	22M	0.019	.097 / .047	.082 / .032	.301 / .251	.301 / .250	.097 / .047	.076 / .026	.054 / .009
10-407552-115	22M	0.019	.035 / NS	.020 / NS	.239 / .189	.239 / .188	.035 / NS	.014 / NS	NS
10-497640-015	20	0.019	.385 / .335	.370 / .320	.589 / .539	.589 / .538	.385 / .335	.364 / .314	.342 / .297
10-497640-025	20	0.019	.250 / .200	.235 / .185	.454 / .404	.454 / .403	.250 / .200	.229 / .179	.207 / .162
10-497640-045	20	0.019	NS	NS	.191 / .141	.191 / .141	NS	NS	NS
10-497596-015	20	0.025	.095 / .049	.080 / .034	.299 / .253	.299 / .252	.095 / .049	.074 / .028	.052 / .011
10-497596-025	20	0.025	.185 / .139	.170 / .124	.389 / .343	.389 / .342	.185 / .139	.164 / .118	.142 / .101
10-497596-035	20	0.025	.266 / .220	.251 / .205	.470 / .424	.470 / .423	.266 / .220	.245 / .199	.223 / .182
10-497596-055	20	0.025	.383 / .337	.368 / .322	.587 / .541	.587 / .540	.383 / .337	.362 / .316	.340 / .299
10-497695-015	16	0.040	.292 / .242	.277 / .227	.496 / .446	.496 / .445	.292 / .242	.271 / .221	.249 / .204
10-497630-035	16	0.062	.097 / .047	.082 / .032	.301 / .251	.301 / .250	.385 / .335	.076 / .026	.054 / .009
10-497630-055	16	0.062	.296 / .250	.281 / .235	.454 / .401	.454 / .401	.232 / .182	.229 / .175	.207 / .158
10-597502-015	12	0.081	.265 / .215	.250 / .200	.469 / .410	.469 / .418	.265 / .215	.244 / .194	.222 / .177

☐ = Standard PC tail used

WIRE HOLE FILLER



WIRE STRIP LENGTH

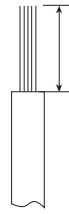

WIRE SEALING RANGE



INSTALLATION TOOLS		WIRE STRIP LENGTHS	WIRE SEALING RANGE	
INSERTION	REMOVAL		MIN.	MAX.
M81969/8-07 or M81969/14-03	M81969/8-08 or M81969/14-03	Contact us for details	.065 (1.65)	.109 (2.77)
M81969/8-09 or M81969/14-04	M81969/8-10 or M81969/14-04	Contact us for details	.097 (2.46)	.142 (3.61)
Hand insertion	M81969/14-12 or DRK264-8 or 11-9170	Contact us for details	.135 (3.43)	.155 (3.94)

All dimensions in inches (millimeters in parenthesis)

PRINTED CIRCUIT BOARD CONTACTS - SOCKET

PCB SOCKET CONTACTS	SIZE	TAIL DIAMETER +/- .001	CONTACT STICKOUT MAX./MIN.						
			MS27466 LJT00RT	MS27656 LJTPQ00RT	MS27496 LJT02RE	MS27505 LJTP02RE	MS27467 LJT06RE	MS27468 LJT07RE	
								(9-17)	(19-25)
10-497623-015	22M	0.019	.328 / .263	.313 / .248	.532 / .467	.532 / .466	.328 / .263	.307 / .424	.285 / .225
10-497623-335	22M	0.019	.264 / .199	.249 / .188	.468 / .406	.468 / .405	.264 / .199	.243 / .182	.221 / .165
10-497623-025	22M	0.019	.905 / .840	.890 / .825	1.109 / 1.044	1.109 / 1.043	.905 / .840	.884 / .819	.862 / .802
10-497623-035	22M	0.019	.385 / .320	.370 / .305	.589 / .524	.589 / .523	.385 / .320	.364 / .299	.342 / .282
10-497623-045	22M	0.019	.245 / .180	.230 / .165	.449 / .384	.449 / .383	.245 / .180	.224 / .159	.202 / .142
10-497623-075	22M	0.019	.183 / .118	.168 / .103	.387 / .322	.387 / .321	.183 / .118	.162 / .097	.140 / .080
10-497623-145	22M	0.019	.646 / .576	.631 / .561	.850 / .780	.850 / .779	.646 / .576	.625 / .555	.603 / .538
10-497623-155	22M	0.019	.460 / .395	.445 / .380	.664 / .599	.664 / .598	.460 / .395	.439 / .374	.417 / .357
10-497643-015	20	0.019	.385 / .339	.370 / .316	.589 / .535	.589 / .536	.385 / .331	.364 / .310	.342 / .293
10-497643-025	20	0.019	.250 / .204	.235 / .181	.454 / .400	.454 / .401	.250 / .196	.229 / .175	.207 / .15
10-497643-035	20	0.019	.592 / .546	.577 / .523	.796 / .742	.796 / .743	.592 / .538	.571 / .517	.549 / .500
10-497650-015	16	0.040	.292 / .246	.277 / .223	.496 / .442	.496 / .443	.292 / .238	.271 / .217	.249 / .200
10-597503-015	12	0.081	.221 / .175	.206 / .152	.425 / .371	.425 / .372	.221 / .167	.200 / .146	.178 / .129

Standard PC tail used

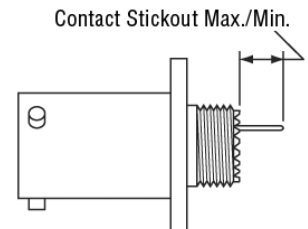

RECEPTACLES

**LJT00RP
(MS27466P)**

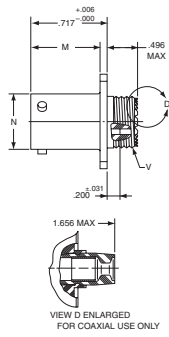
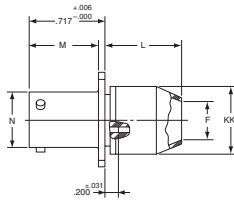

VIEW D ENLARGED FOR COAXIAL USE ONLY

**LJT00RE (MS27466E)
LJT00RT (MS27466T) HE30800T**

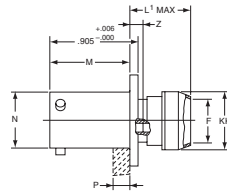
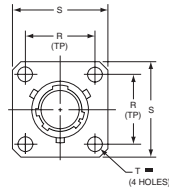

**LJTPQ00RP
(MS27656P)**

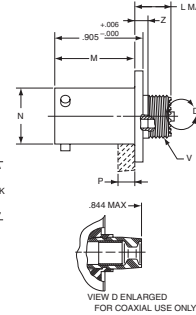

VIEW D ENLARGED FOR COAXIAL USE ONLY

**LJTPQ00RE (MS27656E)
LJTPQ00RT (MS27656T)**

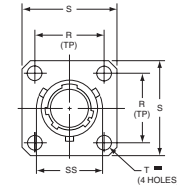

SHELL SIZE	F ±.010	L MAX.		L ¹ MAX.	M +.000 / -.005		N DIA. +.001 / -.005	R (TP)	S DIMENSION		T DIA. ±.005 (±127)	KK DIMENSION MAX.		V THREAD CLASS 2A (PLATED)	Z MAX.	SS DIA.
		MS27466/LJT00R	MS27656/LJTPQ00R	MS27656/LJTPQ00R	MS27466/LJT00R	MS27656/LJTPQ00R			MS27466/LJT00R ±.016	MS27656/LJTPQ00R +.011/-010		MS27466/LJT00R	MS27656/LJTPQ00			
9	0.444 (11.3)	0.813 (20.7)	0.453 (11.5)	0.641 (16.3)	0.632 (16.1)	0.820 (20.8)	0.572 (14.5)	0.719 (18.3)	0.938 (23.8)	0.938 (23.8)	0.128 (3.3)	0.608 (15.4)	0.625 (15.9)	.4375-28 UNEF (3.5)	0.138 (3.5)	0.662 (16.8)
11	0.558 (14.2)	0.813 (20.7)	0.453 (11.5)	0.641 (16.3)	0.632 (16.1)	0.820 (20.8)	0.700 (17.8)	0.812 (20.6)	1.031 (26.2)	1.031 (26.2)	0.128 (3.3)	0.734 (18.6)	0.750 (19.1)	.5625-24 UNEF (3.5)	0.138 (3.5)	0.810 (20.6)
13	0.683 (17.3)	0.813 (20.7)	0.453 (11.5)	0.641 (16.3)	0.632 (16.1)	0.820 (20.8)	0.850 (21.6)	0.906 (23.0)	1.125 (28.6)	1.125 (28.6)	0.128 (3.3)	0.858 (21.8)	0.875 (22.2)	.6875-24 UNEF (3.5)	0.138 (3.5)	0.960 (24.4)
15	0.808 (20.5)	0.813 (20.7)	0.453 (11.5)	0.641 (16.3)	0.632 (16.1)	0.820 (20.8)	0.975 (24.8)	0.969 (24.6)	1.219 (31.0)	1.219 (31.0)	0.128 (3.3)	0.984 (25.0)	1.000 (25.4)	.8125-20 UNEF (3.5)	0.138 (3.5)	1.085 (27.6)
17	0.909 (23.1)	0.813 (20.7)	0.453 (11.5)	0.641 (16.3)	0.632 (16.1)	0.820 (20.8)	1.100 (27.9)	1.062 (27.0)	1.312 (33.3)	1.312 (33.3)	0.128 (3.3)	1.110 (28.2)	1.125 (28.6)	.9375-20 UNEF (3.5)	0.138 (3.5)	1.210 (30.7)
19	1.034 (26.3)	0.813 (20.7)	0.453 (11.5)	0.641 (16.3)	0.632 (16.1)	0.820 (20.8)	1.207 (30.7)	1.156 (29.4)	1.438 (36.5)	1.438 (36.5)	0.128 (3.3)	1.234 (31.3)	1.250 (31.8)	1.0625-18 UNEF (3.5)	0.138 (3.5)	1.317 (33.5)
21	1.159 (29.4)	0.906 (23.0)	0.484 (12.3)	0.672 (17.1)	0.602 (15.3)	0.790 (20.1)	1.332 (33.8)	1.250 (31.8)	1.562 (39.7)	1.562 (39.7)	0.128 (3.3)	1.360 (34.5)	1.375 (34.9)	1.1875-18 UNEF (4.3)	0.168 (4.3)	1.442 (36.6)
23	1.284 (32.6)	0.906 (23.0)	0.484 (12.3)	0.672 (17.1)	0.602 (15.3)	0.790 (20.1)	1.457 (37.0)	1.375 (34.9)	1.688 (42.9)	1.688 (42.9)	0.147 (3.7)	1.484 (37.7)	1.500 (38.1)	1.3125-18 UNEF (4.3)	0.168 (4.3)	1.567 (39.8)
25	1.409 (35.8)	0.906 (23.0)	0.484 (12.3)	0.672 (17.1)	0.602 (15.3)	0.790 (20.1)	1.582 (40.2)	1.500 (38.1)	1.812 (46.0)	1.812 (46.0)	0.147 (3.7)	1.610 (40.9)	1.625 (41.3)	1.4375-18 UNEF (4.3)	0.168 (4.3)	1.692 (43.0)

LJT01RE/LJT01RT/HE30801T

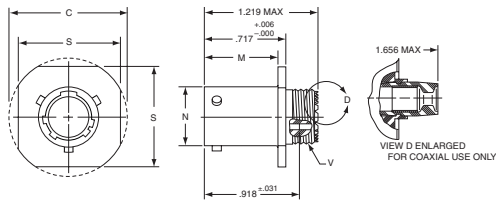

VIEW D ENLARGED FOR COAXIAL USE ONLY

LJT06RP (MS27467P)

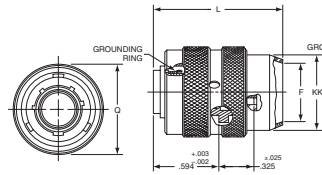

LJT06RE (MS27467E)

LJT06RT (MS27467T) HE30806T

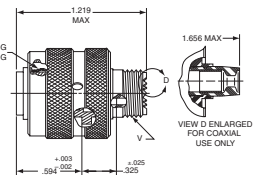

VIEW D ENLARGED FOR COAXIAL USE ONLY

SHELL SIZE	C MAX.	M +.000/-005 (+.000/-127)	N +.000/-005 (+.000/-127)	S ±.016 (±.406)	V THREAD CLASS 2A (PLATED)
9	1.094 (27.8)	0.632 (16.1)	0.572 (14.5)	0.938 (23.8)	.4375-28 UNEF
11	1.188 (30.2)	0.632 (16.1)	0.700 (17.8)	1.031 (26.2)	.5625-24 UNEF
13	1.281 (32.5)	0.632 (16.1)	0.850 (21.6)	1.125 (28.6)	.6875-24 UNEF
15	1.375 (34.9)	0.632 (16.1)	0.975 (24.8)	1.219 (31.0)	.8125-20 UNEF
17	1.469 (37.3)	0.632 (16.1)	1.100 (27.9)	1.312 (33.3)	.9375-20 UNEF
19	1.594 (40.5)	0.632 (16.1)	1.207 (30.7)	1.438 (36.5)	1.0625-18 UNEF
21	1.719 (43.7)	0.602 (15.3)	1.332 (33.8)	1.562 (39.7)	1.1875-18 UNEF
23	1.844 (46.8)	0.602 (15.3)	1.457 (37.0)	1.688 (42.9)	1.3125-18 UNEF
25	1.969 (50.0)	0.602 (15.3)	1.582 (40.2)	1.812 (46.0)	1.4375-18 UNEF

SHELL SIZE	F ±.010	L MAX.	Q MAX.	KK DIAMETER MAX.	V THREAD CLASS 2A (PLATED)
9	0.444 (11.3)	1.531 (38.9)	0.844 (21.4)	0.608 (15.4)	.4375-28 UNEF
11	0.558 (14.2)	1.531 (38.9)	0.969 (24.6)	0.734 (18.6)	.5625-24 UNEF
13	0.683 (17.3)	1.531 (38.9)	1.141 (29.0)	0.858 (21.8)	.6875-24 UNEF
15	0.808 (20.5)	1.531 (38.9)	1.266 (32.2)	0.984 (25.0)	.8125-20 UNEF
17	0.909 (23.1)	1.531 (38.9)	1.391 (35.3)	1.110 (28.2)	.9375-20 UNEF
19	1.034 (26.3)	1.531 (38.9)	1.500 (38.1)	1.234 (31.3)	1.0625-18 UNEF
21	1.159 (29.4)	1.625 (41.3)	1.625 (41.3)	1.360 (34.5)	1.1875-18 UNEF
23	1.284 (32.6)	1.625 (41.3)	1.750 (44.5)	1.484 (37.7)	1.3125-18 UNEF
25	1.409 (35.8)	1.625 (41.3)	1.875 (47.6)	1.610 (40.9)	1.4375-18 UNEF

All dimensions in inches (millimeters in parenthesis)

RECEPTACLES

LJT02RE (MS27496E)

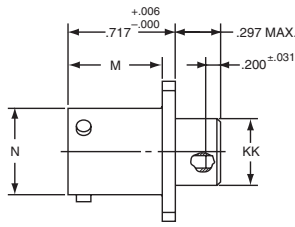

LJTP02RE (MS27505E)

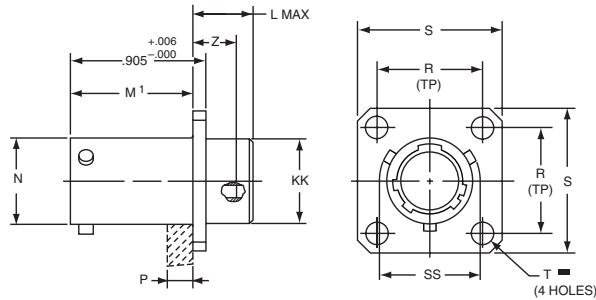

SHELL SIZE	L MAX.	M +0.00/-0.005 (+0.00/-0.127)	M1 +0.01/-0.005 (+0.00/-0.127)	N DIAMETER +0.01/-0.005 (+0.25/-0.127)	P MAX. PANEL THICKNESS	R (TP)	S +0.01/-0.010 (+0.279/-0.254)	T DIAMETER ±0.005 (±0.127)	Z ±0.031 (±0.787)	KK DIAMETER +0.006/-0.005 (+0.152/-0.127)	SS DIAMETER +0.000/-0.016 (+0.000/-0.406)
9	0.203 (5.2)	0.632 (16.1)	0.820 (20.8)	0.572 (14.5)	0.234 (5.9)	0.719 (18.3)	0.938 (23.8)	0.128 (3.3)	0.107 (2.7)	0.433 (11.0)	0.662 (16.8)
11	0.203 (5.2)	0.632 (16.1)	0.820 (20.8)	0.700 (17.8)	0.234 (5.9)	0.812 (20.6)	1.031 (26.2)	0.128 (3.3)	0.107 (2.7)	0.557 (14.1)	0.810 (20.6)
13	0.203 (5.2)	0.632 (16.1)	0.820 (20.8)	0.850 (21.6)	0.234 (5.9)	0.906 (23.0)	1.125 (28.6)	0.128 (3.3)	0.107 (2.7)	0.676 (17.2)	0.960 (24.4)
15	0.203 (5.2)	0.632 (16.1)	0.820 (20.8)	0.975 (24.8)	0.234 (5.9)	0.969 (24.6)	1.219 (31.0)	0.128 (3.3)	0.107 (2.7)	0.801 (20.3)	1.085 (27.6)
17	0.203 (5.2)	0.632 (16.1)	0.820 (20.8)	1.100 (27.9)	0.234 (5.9)	1.062 (27.0)	1.312 (33.3)	0.128 (3.3)	0.107 (2.7)	0.926 (23.5)	1.210 (30.7)
19	0.203 (5.2)	0.632 (16.1)	0.820 (20.8)	1.207 (30.7)	0.234 (5.9)	1.156 (29.4)	1.438 (36.5)	0.128 (3.3)	0.107 (2.7)	1.032 (26.2)	1.317 (33.5)
21	0.234 (5.9)	0.602 (15.3)	0.790 (20.1)	1.332 (33.8)	0.204 (5.2)	1.250 (31.8)	1.562 (39.7)	0.128 (3.3)	0.137 (3.5)	1.157 (29.4)	1.442 (36.6)
23	0.234 (5.9)	0.602 (15.3)	0.790 (20.1)	1.457 (37.0)	0.204 (5.2)	1.375 (34.9)	1.688 (42.9)	0.147 (3.7)	0.137 (3.5)	1.282 (32.6)	1.567 (39.8)
25	0.234 (5.9)	0.602 (15.3)	0.790 (20.1)	1.582 (40.2)	0.193 (4.9)	1.500 (38.1)	1.812 (46.0)	0.147 (3.7)	0.137 (3.5)	1.407 (35.7)	1.692 (43.0)

LJT07RP (MS27468P)

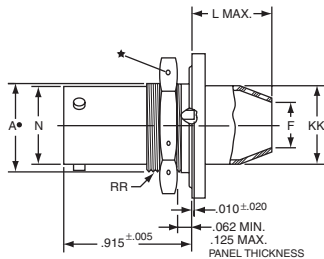
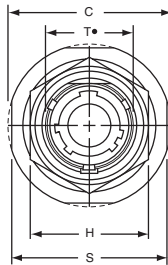

LJT07RE (MS27468E)

LJT07RT (MS27468T) HE30807T

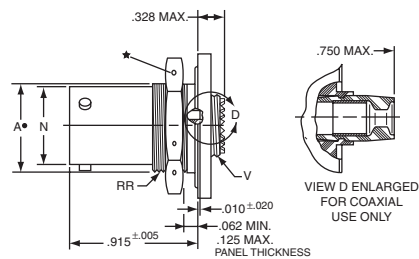

SHELL SIZE	A* +0.00/-0.010 (+0.000/-0.254)	C MAX.	F ±.010	H HEX. +0.017/-0.016 (+0.432/-0.406)	L MAX.	N +0.01/-0.005 (+0.25/-0.127)	S ±0.016 (±0.406)	T* +0.010/-0.000 (+0.254/-0.000)	V THREAD CLASS 2A (PLATED)	KK DIAMETER MAX.	RR THREAD CLASS 2A (PLATED)
9	0.669 (17.0)	1.199 (30.5)	0.444 (11.3)	0.875 (22.2)	0.625 (15.9)	0.572 (14.5)	1.062 (27.0)	0.697 (17.7)	.4375-28 UNEF	0.608 (15.4)	.6875-24 UNEF
11	0.769 (19.5)	1.386 (35.2)	0.558 (14.2)	1.000 (25.4)	0.625 (15.9)	0.700 (17.8)	1.250 (31.8)	0.822 (20.9)	.5625-24 UNEF	0.734 (18.6)	.8125-20 UNEF
13	0.955 (24.3)	1.511 (38.4)	0.683 (17.3)	1.188 (30.2)	0.625 (15.9)	0.850 (21.6)	1.375 (34.9)	1.007 (25.6)	.6875-24 UNEF	0.858 (21.8)	1.0000-20 UNEF
15	1.084 (27.5)	1.636 (41.6)	0.808 (20.5)	1.312 (33.3)	0.625 (15.9)	0.975 (24.8)	1.500 (38.1)	1.134 (28.8)	.8125-20 UNEF	0.984 (25.0)	1.1250-18 UNEF
17	1.208 (30.7)	1.761 (44.7)	0.909 (23.1)	1.438 (36.5)	0.625 (15.9)	1.100 (27.9)	1.625 (41.3)	1.259 (32.0)	.9375-20 UNEF	1.110 (28.2)	1.2500-18 UNEF
19	1.333 (33.9)	1.949 (49.5)	1.034 (26.3)	1.562 (39.7)	0.656 (16.7)	1.207 (30.7)	1.812 (46.0)	1.384 (35.2)	1.0625-18 UNEF	1.234 (31.3)	1.3750-18 UNEF
21	1.459 (37.1)	2.073 (52.7)	1.159 (29.4)	1.688 (42.9)	0.750 (19.1)	1.332 (33.8)	1.938 (49.2)	1.507 (38.3)	1.1875-18 UNEF	1.360 (34.5)	1.5000-18 UNEF
23	1.580 (40.1)	2.199 (55.9)	1.284 (32.6)	1.812 (46.0)	0.750 (19.1)	1.457 (37.0)	2.062 (52.4)	1.634 (41.5)	1.3125-18 UNEF	1.484 (37.7)	1.6250-18 UNEF
25	1.709 (43.4)	2.323 (59.0)	1.409 (35.8)	2.000 (50.8)	0.750 (19.1)	1.582 (40.2)	2.188 (55.6)	1.759 (44.7)	1.4375-18 UNEF	1.610 (40.9)	1.7500-18 UNS

• "D" shaped mounting hole dimensions

All dimensions in inches (millimeters in parenthesis)

ACCESSORIES



LJT SHELL SIZE	DUMMY RECEPTACLES	RECEPTACLE DUST CAPS		PLUG CAP
		FOR FLANGED	FOR JAM NUT	
9	M38999/9-9B	MS27502**9C	MS27502**9N	MS27501**9C
11	M38999/9-11B	MS27502**11C	MS27502**11N	MS27501**11C
13	M38999/9-13B	MS27502**13C	MS27502**13N	MS27501**13C
15	M38999/9-15B	MS27502**15C	MS27502**15N	MS27501**15C
17	M38999/9-17B	MS27502**17C	MS27502**17N	MS27501**17C
19	M38999/9-19B	MS27502**19C	MS27502**19N	MS27501**19C
21	M38999/9-21B	MS27502**21C	MS27502**21N	MS27501**21C
23	M38999/9-23B	MS27502**23C	MS27502**23N	MS27501**23C
25	M38999/9-25B	MS27502**25C	MS27502**25N	MS27501**25C

** Select code for plating

- B = Olive Drab Chromate over Cadmium over Nickel (500-Hour Salt Spray) (Most Popular)
- F = Electroless Nickel (Fluid-Resistant)
- A = Gold Iridite over Cadmium Nickel
- C = Hard Anodize



Straight

Right Angle

LJT SHELL SIZE	ENDBELLS		CABLE RANGE	
	STRAIGHT, LOW-COST	RIGHT-ANGLE, LOW-COST	MIN.	MAX.
9	M85049/49-2-8**	M85049/47**8	.098 (2.50)	.234 (5.94)
11	M85049/49-2-10**	M85049/47**10	.153 (3.89)	.234 (5.94)
13	M85049/49-2-12**	M85049/47**12	.190 (4.83)	.328 (8.33)
15	M85049/49-2-14**	M85049/47**14	.260 (6.60)	.457 (11.61)
17	M85049/49-2-16**	M85049/47**16	.283 (7.19)	.614 (15.60)
19	M85049/49-2-18**	M85049/47**18	.325 (8.25)	.634 (16.10)
21	M85049/49-2-20**	M85049/47**20	.343 (8.71)	.698 (17.73)
23	M85049/49-2-22**	M85049/47**22	.381 (9.68)	.823 (20.90)
25	M85049/49-2-24**	M85049/47**24	.418 (10.62)	.853 (21.67)

** Select code for connector plating

- W = Olive Drab Chromate over Cadmium over Nickel (1000-Hour Salt Spray)
- N = Electroless Nickel (Fluid-Resistant)
- A = Black Anodize

All dimensions in inches (millimeters in parenthesis)





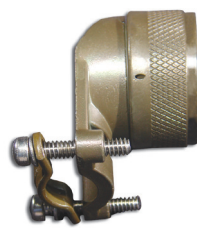

Straight

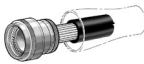

Right Angle

LJT SHELL SIZE	SELF-LOCKING ENDBELLS, STRAIGHT	CABLE RANGE, RIGHT-ANGLE	MIN.	MAX.
9	M85049/49-2S8**	M85049/47S**8	.098 (2.49)	.234 (5.94)
11	M85049/49-2S10**	M85049/47S**10	.153 (3.89)	.234 (5.94)
13	M85049/49-2S12**	M85049/47S**12	.190 (4.83)	.328 (8.33)
15	M85049/49-2S14**	M85049/47S**14	.260 (6.60)	.457 (11.61)
17	M85049/49-2S16**	M85049/47S**16	.283 (7.19)	.614 (15.60)
19	M85049/49-2S18**	M85049/47S**18	.325 (8.25)	.634 (16.10)
21	M85049/49-2S20**	M85049/47S**20	.343 (8.71)	.698 (17.73)
23	M85049/49-2S22**	M85049/47S**22	.381 (9.68)	.823 (20.90)
25	M85049/49-2S24**	M85049/47S**24	.418 (10.62)	.853 (21.67)

** Select code for connector plating
 W = Olive Drab Chromate over Cadmium over Nickel (1000-Hour Salt Spray)
 N = Electroless Nickel (Fluid-Resistant)
 S = 300 Series Steel, Passivated

	SEALED	EMI/RFI	S = STRAIGHT A = 90° B = 45°	ORIENTATION	DESCRIPTION
M85049/62 	Y	N	S	Heat Shrink Boot Adapters	Designed for use with straight or right angle shrink boots. A knurled rear section with a boot groove provides excellent surface for the boot to grab the metal endbell. Available with lock wire and drain holes. See Heat Shrink Boots on pages 367-369 .
M85049/33 M85049/32 	N	Y	S A	Shield Termination Back Shell	Non-environmental designed for use with jacketed cable. Allow extra space to break out the wires and still provide strain relief clamping to the outside of the cable jacket.
M85049/17 	Y	Y	S	Extender Back Shell	This EMI/RFI-shielding, environmentally-sealed endbell features a standard-style cable clamp with gland seal at the end of an extender-style backshell.
M85049/29 	N	N	S	Extender Back Shell	This EMI/RFI-shielding, non-environmentally-sealed endbell features a standard-style cable clamp.
Banding  M85049/85 M85049/86 M85049/87	Y	Y	S B A	Banding Adapter	Banding adapters utilize a band of metal that fastens and grounds cable shields to the outside of endbells. This method of terminating shields has advantages in that they typically use tools to tighten and trim the bands. These tools make the termination tight, repeatable, reworkable (if you make a mistake, just cut the band off and start again) and facilitates service. Banding adapters help lower the total applied cost by having simpler designs that have fewer parts with uncomplicated assembly procedures.
Custom			SAB	Custom Designs Contact us	If the military-standard endbells don't fit your needs, contact us and we will customize an endbell solution. Most of these customized endbells are typically assembled in 4-8 weeks or sooner!
M85049/27	N	N	S	E-Nut	Wire seal compression nut

All dimensions in inches (millimeters in parenthesis)

WIRE STRIPPING

Strip insulation from end of wire to be crimped. (See table for proper stripping dimensions.) Do not cut or damage wire strands.

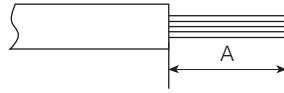

WIRE SIZE	A
22, 22M, 22D	.125 (3.18)
20	.188 (4.77)
16	.188 (4.77)
12	.188 (4.77)
10	.335 (8.51)
8 (power)	.470 (11.99)

CONTACT CRIMPING

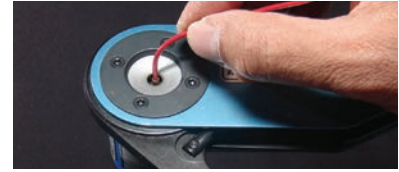
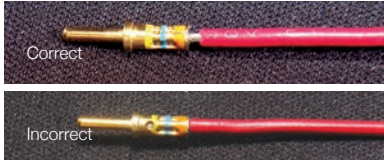

STEP 1: Insert wire into rear of contact. Wire insulation must press against rear of contact. Wire must be visible through inspection hole.

STEP 2: M22520 series crimp tool and locator is recommended. See Contact and Tool Table on pages 182 and 183 for choice of turret head and selection setting according to contact size, part number and wire gauge size.

STEP 3: Insert contact and wire into tool jaws. To crimp, squeeze handles together fully until ratchet releases and allows handles to expand; otherwise, contact cannot be extracted from tool jaws. Maintain slight insertion pressure on wire while crimping contact to wire.

CONTACT INSERTION



STEP 1: Remove hardware from plug or receptacle and slip over wire bundle in proper order for reassembly.



STEP 2: Using proper plastic or metal insertion tool for corresponding contact, position wire in tip of the tool so that the tool tip presses against the contact shoulder.



STEP 3: Press tool against contact shoulder and, with firm and even pressure, insert wired contact and tool tip into center contact cavity.

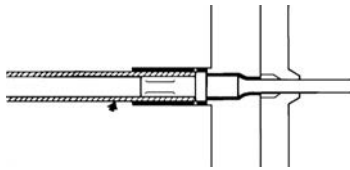

STEP 4: When contact bottoms, a slight "click" can be heard as tines of metal retaining clip snap into place behind contact shoulder.



STEP 5: Remove tool and pull back lightly on wire to make sure contact is properly seated. Repeat operation with remainder of contacts to be inserted, beginning with the center cavity and working outward in alternating rows.



STEP 6: After all contacts are inserted, fill any empty cavities with wire sealing plugs. Reassemble plug or receptacle hardware.

CONTACT EXTRACTION



STEP 1: Remove hardware from plug or receptacle and slide hardware back along wire bundle.

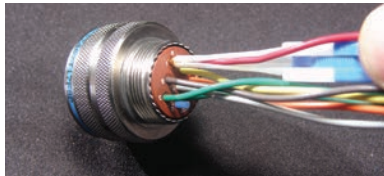

STEP 2: Using plastic or metal extraction tool with proper color code corresponding to contact size, place wire in tool.

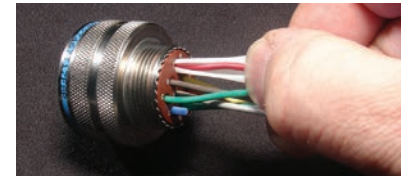

STEP 3: Insert tool into contact cavity until tool tip bottoms against the contact shoulder, expanding clip retaining tines.

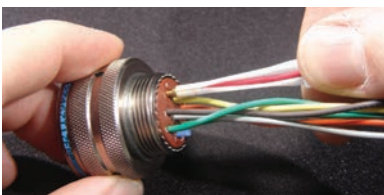

STEP 4: Hold wire firmly in tool and extract wired contact and tool. Repeat operation for all contacts to be extracted.



STEP 5: Fill any empty cavities with wire sealing plugs. Reassemble plug or receptacle hardware.

All dimensions in inches (millimeters in parenthesis)