

POWER-SUBCON PSC 1,5/...

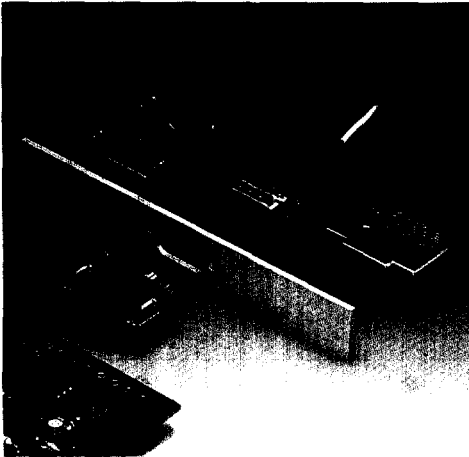

POWER-SUBCON combines the principle of the MINI-COMBICON plug connectors with the good shielding features and the geometry of the D-SUB connectors.

The original 9-position D-SUB connector turns into a 3-position POWER-SUBCON, and there are 5 screw connections in the 15-position D-SUB connector. Both connector types can be inserted into standard D-SUB housings.

The high current carrying capacity of 8 A for a rated voltage of 250 V is a result of the robust MINI-COMBICON screw connection.

The headers are optionally available with a capacitive ground connection for both numbers of positions.

Articles printed in bold can be delivered at short notice.
Products with black or gray housing available on request.

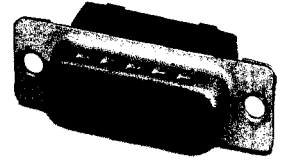

PSC 1,5/...-F POWER-SUBCON plug

(IEC) [mm ²]	rigid solid	flexible stranded	AWG	I [A]	U [V]
Connection data	0.14-1.5	0.14-1.5	28-16	8	250*

* For applications in metal or metal-plated housings, the protection class "safety extra-low voltage" must be used.

Note:
Only actuate MINI-COMBICON plug connectors when under no load condition. If for operating reasons small loads must be switched, experimental values are available on request.

Description	No. of positions
POWER-SUBCON plugs , shielded, color: green	3 5
POWER-SUBCON header , shielded, color: green, for walls up to 2.0 mm thick or 4.5 mm thick with distance bolts SW 5 L5/4-40 UNC-M 3 x 8	3 5
POWER-SUBCON header , as above, however, with capacitive ground connection	3 5
POWER-SUBCON cable housing	3 5

Type	Order No.	Pcs. Pkt.
PSC 1,5/3-F	18 41 90 9	50
PSC 1,5/5-F	18 41 91 2	
SCT-D-SUB 9-KG	27 49 55 0	10
SCT-D-SUB 15-KG	27 49 56 3	10

Approval data (UL and CSA)

Nominal voltage / current / conductor sizes UL: [V] / [A] / AWG
CSA: [V] / [A] / AWG

300 / 8 / 30-14
300 / 8 / 28-16

SCT-D-SUB 9-KG

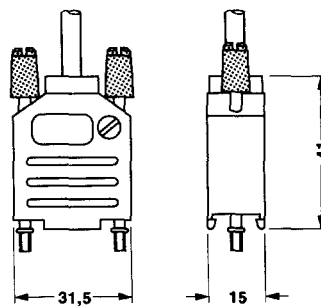

SCT-D-SUB 15-KG

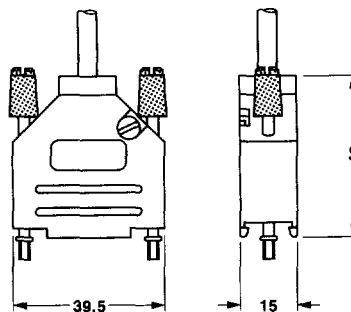

PSC 1,5/3-F

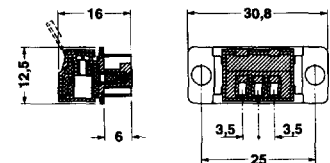

PSC 1,5/5-F

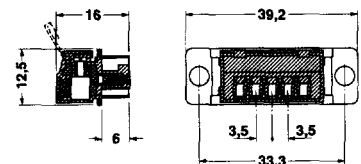

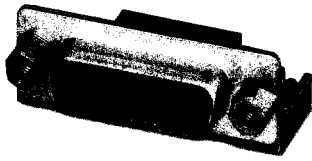

PSC 1,5/...-M
POWER-SUBCON
header

Connection data	I	U
	[A]	[V]
	8	250



Type	Order No.	Pcs. Pkt.
PSC 1,5/3-M	18 41 85 7	50
PSC 1,5/5-M	18 41 89 9	50
PSC 1,5/3-M-PE	18 48 12 2	50
PSC 1,5/5-M-PE	18 48 13 5	

300 / 8 / -
300 / 8 / -

Drilling diagram PSC 1,5/3-M(-PE)

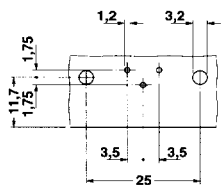

Drilling diagram PSC 1,5/5-M(-PE)

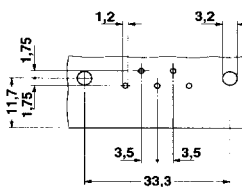

Panel cutout acc. to DIN 41 652-3
for walls up to 2.0 mm thick

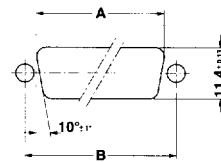

PSC 1,5/3-M

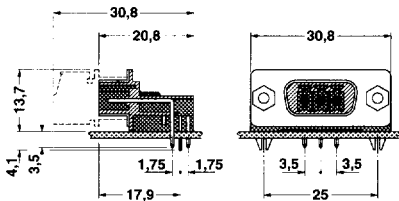

PSC 1,5/3-M-PE

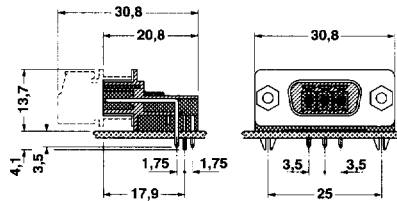

Panel cutout acc. to DIN 41 652-3
for walls up to 4.5 mm thick

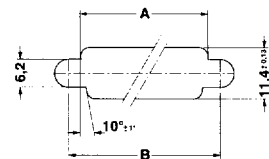

PSC 1,5/5-M

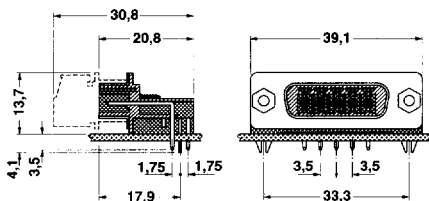

PSC 1,5/5-M-PE

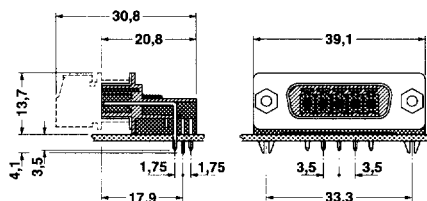

Housing cutout dimensions PSC 1,5/...M(-PE)

No. of pos.	a [mm]	b [mm]
3	20.5 ± 0.13	25.0 ± 0.13
5	28.8 ± 0.13	33.3 ± 0.13